

Uniforms & Body Armor

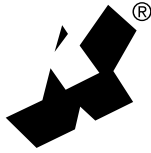





SOMMARIO

INDEX

Giubbini Antiproiettile Body armour	18	Tubolari Shoulder straps	112
Anfibi e Scarpe Boots and shoes	31	Gradi - Spille - Qualifiche e specialità Metal ranks	114
Berretti Classici Caps	38	Camici - Casacche - Tute Overall	116
Cappelli e Baschi Caps	41	Pettorine - fascie da braccio alta visibilità Gilet	117
Giubbini Giacche a vento Jackets	42	Accessori vari Protezione Accessories	119
Rainjacket - k-way - Impermeabili - Softshell Wind jackets	53	Metal detector e Specchi Metal detector-Under vehicle inspection	120
Giacche Camicie operative - Combat shirt Jackets	60	Torçe Maglite - Favor Flashlights	122
Maglioni Sweaters	63	Fari Brandeggianti Searching lights	124
Pile - Intimo termico Pile - Underwear	68	Cassette Pronto soccorso defibrillatore First aid	126
Camicie guardia - Camicie Classiche Shirts	70	Cinture e Cinturoni - Fondine - Accessori Belts	128
Polo Polo	78	Porta tessere per placca Leather badge	133
Pantaloni operativi 6 tasche Trousers	80	Guanti Gloves	134
Giacche Diagonali - Giacche classiche lana Uniform jackets - Classic jackets	83	Borse e Borsoni Bags	136
Pantaloni - Gonne lana Trousers	88	Manganelli e Manette Baton and handcuff	137
Giacche Classiche poliviscosa Jackets viscoso polyester	90	Abbigliamento Kimay Kimay sport and free time	138
Pantaloni - Gonne poliviscosa Trousers - Skirt viscoso polyester	92	Specifiche misure dei capi Kimay Size table	140
Cravatte - Ascott - Foulard Tie - Ascott - Foulard	94	Schede presa misura uomo Size table man	146
Placche Metallo - Alamari Emblems	96	Schede presa misura donna Size table woman	147
Stemmi Ricamati Patch	104		



Diamo **stile** 
a chi ci **sceglie**



**Proteggiamo
chi ci protegge**

La **forza** del **team**





CONTATTI AZIENDALI

Legale Rappresentante Amministratore

Luigi Taffi
luigi.taffi@kimay.it

Responsabile Aziendale

Elena Medolago
elena.medolago@kimay.it

Addetti vendita

Alice Pesenti
alice.pesenti@kimay.it

Claudio Medolago
claudio.medolago@kimay.it

Davide Maggi
davide.maggi@kimay.it

Produzione e Prototipi

Gabriela Franzoni
gabriela.franzoni@kimay.it

Responsabile Amministrativo

Daniela Midali
daniela.midali@kimay.it

Certificazioni e Qualità

Orietta Gotti
orietta.gotti@kimay.it

LEGENDA
n° operatori vestiti
ed equipaggiati

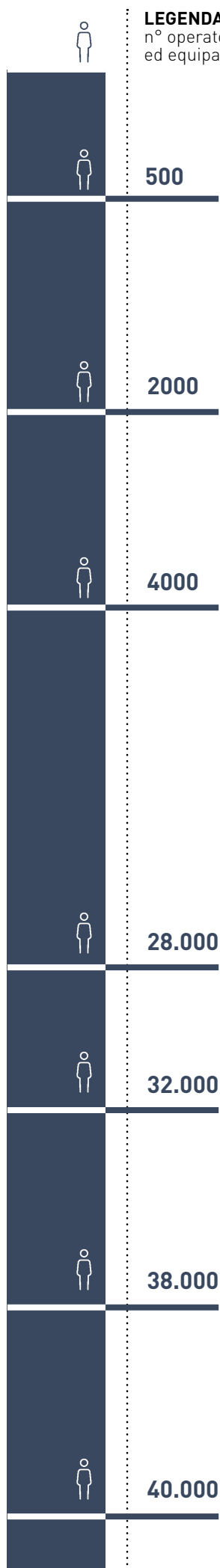

1989



FASE COMMERCIALE

Kimay nasce nel 1989 come azienda commerciale di prodotti militari.

COMMERCIAL PHASE

Founded in 1989, Kimay began as a military product company.

1993



FASE PRODUTTIVA

La fase produttiva è la naturale evoluzione di un'azienda che sa cosa vuole proporre sul mercato e decide di realizzare su proprie specifiche, per questo dal 1993 Kimay si dedica allo studio e alla produzione di divise, sia direttamente che indirettamente, attraverso subfornitori selezionati.

MANUFACTURING PHASE

The manufacturing phase is the logical next step in the evolution of a company that knows what it wants to offer the market and decides to do so according to their specifications. In 1993, Kimay dedicated itself to directly and indirectly researching, developing, and manufacturing uniforms through selected sub suppliers.

1997



BODY ARMOUR

dopo anni di collaborazione e produzione con primarie aziende nel settore militare, Kimay decide di riversare il know how produttivo anche nelle protezioni balistiche; dopo soli 5 anni, Kimay diventa il primo produttore di Giubbini antiproiettile nel mercato civile.

BODY ARMOR

After years of collaboration and manufacturing with the leading firms in the military sector, Kimay leveraged their manufacturing and ballistic protection expertise, and after only five years, Kimay became the number one bulletproof body armor manufacturer in the civil market.

2005



UN SERVIZIO 4.0

Lo sviluppo del settore divise, ampliandosi alla Polizia Locale ed alla Protezione Civile, anche grazie ad una qualità di prodotto e servizio sempre più riconosciuta, raggiunge volumi che richiedono organizzazione ed informatizzazione. Per questo Kimay entra in partecipazione nel capitale di Ribo S.r.l. specializzata in IT e soprattutto in soluzioni gestionali, con la quale è stato sviluppato il portale Centro Vigilanza On line che permette agli istituti di gestire e monitorare gli approvvigionamenti Kimay in tempo reale.

4.0 SERVICE

Growth in the uniform sector, expansion to the Local Police and Civil Protection Department, and our acclaimed product and service quality, led Kimay to achieve production volumes that required computerization and organization. To meet the growing demand, Kimay invested in share capital of Ribo, LLC, a firm specialized in IT and management solutions. As a result, the Online Security Center portal was developed, enabling companies to manage and monitor Kimay supplies in real time.

2007



L'ATELIER DELLE DIVISE

Nel 2007 Kimay ha sviluppato al suo interno un laboratorio specializzato nella realizzazione di capi spalla e capi su misura.

THE UNIFORM ATELIER

In 2007, Kimay established a laboratory specialized in creating custom jackets and outerwear.

2008



INGRESSO MA.DI.SH

Nel 2008 Kimay è entrata in società con Ma.di.sh (Shkoder in Albania), azienda produttiva specializzata nella realizzazione di camicie, pantaloni, giacche a vento. La partnership con Kimay, grazie all'apporto di competenza e macchinari di ultima generazione, consente di offrire sul mercato dei prodotti con un impareggiabile rapporto costo/qualità.

THE MA.DI.SH DEBUT

In 2008, Kimay entered into a partnership with Ma.di.sh (Shkoder in Albania), a manufacturing company specialized in creating shirts, pants, and windbreakers. The partnership resulted in providing the market with an incomparable cost to quality ratio thanks to Kimay's contribution of expertise and state-of-the-art machinery.

2011



FORNITURA POLIZIA TICINESE

Kimay vince un'agguerrita competizione tra i maggiori produttori europei per la fornitura, tuttora in corso, che rappresenta un fiore all'occhiello per il livello qualitativo richiesto. Kimay infatti fornisce la Polizia Ticinese ed i relativi corpi speciali con giubbini antiproiettile classe 3A ed anticoltello SK25Joule realizzati su misura, uno a uno, in fibra aramidica ARTEC®.

TICINO POLICE SUPPLY

Competing among the largest producers in Europe, Kimay won a hard-fought victory for the flagship supply contract which continues to this day. Kimay provides the Ticino Police and their respective Special Corps with made-to-order Class 3A bulletproof and SK25 Joule anti-knife vests. Each vest is made with ARTEC® aramid fiber.



LEGENDA
n° operatori vestiti
ed equipaggiati

2013

41.000



AMPLIAMENTO MAGAZZINI

Per fare fronte alle sempre maggiori richieste e soprattutto per garantire quel servizio che solo un adeguato assortimento può offrire, è stata raddoppiata la capacità di magazzino che oggi conta una superficie di 3.000 mq compartimentata e sfruttata su più livelli per una logistica interna ottimizzata.

WAREHOUSE EXPANSION

In order to meet the market's ever-increasing demand and ensure the service that only a suitable assortment can offer, Kimay doubled their warehouse size. The warehouse has a 3000 m² surface area that is partitioned with multi-level use to guarantee optimized internal logistics.

2015

41.000



EXPO 2015

L'esposizione internazionale a Milano è stata una sfida ed un'opportunità di crescita organizzativa che Kimay ha affrontato affiancando i propri clienti nella vestizione di 3.500 soggetti.

EXPO 2015

At the International Expo in Milan, Kimay was given an opportunity for organizational growth and rose to the challenge by collaborating with their clients to outfit 3500 people.

2017

46.000



PARTNERSHIP PRODUTTIVA FAR EAST

Nella moderna economia di mercato non è pensabile svilupparsi senza un ponte con la capacità produttiva asiatica.

Kimay, nel solco del proprio approccio qualitativo, ha instaurato una partnership tecnica a Shanghai che ha consentito di selezionare produttori e materiali allineati con i più alti standard europei.

FAR EAST MANUFACTURING PARTNERSHIP

In today's market, it's impossible for a company to evolve without Asian manufacturing capabilities. In keeping with their quality method, Kimay established a technical partnership in Shanghai that allowed them to select producers and materials that adhered to the highest European standards.

2018

44.000



PARTNERSHIP CON TALAN

L'esigenza di equipaggiare gli operatori con materiali capaci di coniugare confort, protezione e durabilità ha comportato una ricerca decennale che è sfociata nella partnership con l'ucraina Talan, uno dei maggiori produttori continentali di calzature per il settore militare (dal 1923) che oggi dispone di tecnologie esclusive e collaudate.

TALAN PARTNERSHIP

The demand for equipping operators with materials that incorporate comfort, protection, and durability required a decade of research, resulting in a partnership with the Ukrainian firm Talan. Since 1923, Talan has been one of the largest European producers of shoes for the military sector and has unparalleled, tried-and-true technology at its disposal.

2020

52.000



PARTNERSHIP CON SICUR GROUP – SICURON ACADEMY

La crisi sanitaria del 2020 ha offerto a Kimay l'occasione di collaborare con securON, società leader nell'integrazione tra safety e security per lo sviluppo di una mascherina omologata ad alte prestazioni appositamente studiata per la protezione degli operatori security. Da questo progetto è nata la collaborazione con securON Academy dove istruttori altamente qualificati possono testare nei diversi scenari addestrativi i materiali ed i prototipi Kimay.

PARTNERSHIP WITH SICUR GROUP-SICURON ACADEMY

The 2020 pandemic offered Kimay the opportunity to collaborate with securON, the leading company in the integration of safety and security for the development of a high-performance homologated mask perfected for the protection of security workers. The project led to Kimay's collaboration with securON Academy where highly-qualified instructors can test Kimay materials and prototypes in different training scenarios.

2021

68.000



NASCITA SICUR SERVICES

Con la partecipazione di Kimay, securON e PRSE Engineering nasce secur SERVICES, che offre servizi tecnici per la sicurezza e l'antincendio. Questo collegamento consente importanti sinergie tecniche e commerciali tra i partners per la protezione dei lavoratori a 360°. Sicur SERVICES è anche il distributore esclusivo della linea safety di TALAN che completa la linea tattica già importata con successo da Kimay.

SICUR SERVICES IS BORN

With the participation of Kimay, securON, and PRSE Engineering, secur SERVICES was born. Sicur SERVICES offers technical safety and flame-retardant services. This relationship allows an important technical and commercial synergy among the partners for 360° worker protection. Sicur SERVICES is also the sole distributor of the TALAN safety line, completing the tactical line successfully imported by Kimay.











Ribo, partner indipendente partecipato da Kimay è una struttura con oltre 20 anni di esperienza ed un team di 40 professionisti è in grado di proporre soluzioni concrete, efficienti, personalizzate ed integrate, nei seguenti settori:

- Business Solutions
- IT Solutions
- App & Software
- Communication

Ribo diventa quindi una risorsa sinergica per lo sviluppo di Kimay e dei suoi partners.



Partner strategico di Kimay in Cina e nel sud est asiatico.

Kimay, vista la crescente domanda di forniture di sicurezza e la necessità di ovviare al problema della sua capacità produttiva, ha portato la confezione di alcuni suoi prodotti in Asia.

Grazie al know-how, al controllo costante di qualità in loco tramite un ufficio dedicato e ad una gestione logistica si sono raggiunti standard molto simili a quelli italiani.



Sicur SERVICES, partner indipendente partecipato da

Kimay, nasce per fornire soluzioni tecniche per la sicurezza dei lavoratori e l'antincendio.

Un team di specialisti con esperienza ultraventennale ed una divisione engineering interna possono soddisfare le più complesse esigenze di prevenzione incendi.

La partnership con i maggiori operatori italiani della sicurezza e prevenzione consentono di soddisfare ogni esigenza di fornitura di soluzioni tecniche, DPI e materiali.



SicurON, partner indipendente di Kimay, è una struttura che si occupa di consulenza a formazione con competenze specialistiche nell'**integrazione tra safety e security**, diventando in questo ambito peculiare uno dei protagonisti a livello nazionale.

La motivazione etica sempre coniugata con una spinta all'innovazione ed all'efficienza sono l'essenza della "vision" di sicurON finalizzata a soddisfare obiettivi condivisi.

Il nostro team si occupa di sicurezza sul lavoro dal 1994 avendo maturato una esperienza sul campo in attività industriali ad alto rischio.

Le competenze acquisite ci consentono di affrontare le situazioni più complesse e di proporre soluzioni efficaci e su misura in diversi settori.



Associato a





AUTOMATION



AEROSPACE



ZOOTECH



R&D

PRSE, co-investigatore con Kimay in **sicur SERVICES** è una società di engineering che offre competenze avanzate per la progettazione e lo sviluppo ad hoc di sistemi di automazione industriale.

PRSE ha nella propria Mission, il posizionamento a livello globale grazie all'alta competenza delle persone che ne fanno parte per conseguire:

- L'esplorazione continua delle nuove tecnologie, volta a definire i nuovi standard di sicurezza e di processo, senza trascurare obiettivi "green".
- La partecipazione allo sviluppo delle tecnologie innovative tramandando il sapere che ha fatto grande il Made in Italy.

Un team dedicato individua la struttura e le soluzioni di "system integration" più funzionali e produttive, senza limitazioni settoriali e facendo comunque tesoro delle significative esperienze maturate in contesti nei quali PRSE ha vinto le competizioni con i maggiori player.

Il futuro è già iniziato e PRSE ne vuole essere protagonista.



L'Academy di **sicurON** nasce dall'analisi delle esigenze dei Committenti, negli ambiti della Sicurezza Pubblica e Privata e delle Polizie Locali.

L'approccio formativo dell'Academy si basa sull'esperienza ultraventennale dei propri docenti ed istruttori non prescinde mai dall'analisi di poteri e funzioni degli operatori, dalle attitudini individuali e da una concreta valutazione delle circostanze di impiego, per conseguire obiettivi di efficacia e Sicurezza dell'Operatore.

La partnership con **Kimay** è una preziosa opportunità per le sinergie di sviluppo che ne derivano.

La fase addestrativa prevede l'analisi e la **simulazione degli scenari critici**, offrendo un'imperdibile occasione di collaudo operativo dei materiali in cui esperti istruttori, con curriculum di primordine anche nelle FFAA e nelle FFOO, hanno l'opportunità di testare indumenti ed accessori all'avanguardia, fornendo a Kimay dei feedback funzionali già in fase prototipale o di selezione del fornitore.



KimayFit

Presenza misure tramite la app Kimay fit Android e iOS

Con Kimay fit, l'utente ha la possibilità di conoscere la sua taglia in maniera semplice ed intuitiva, la app suggerirà quali saranno le taglie corrette per ogni singolo articolo. Gli articoli potranno essere messi nel carrello ed inviati direttamente a noi, che procederemo alla spedizione.

Protezione della privacy

Tutti i calcoli e l'elaborazione delle immagini vengono eseguiti nel dispositivo. Nessuna immagine viene inviata o salvata.

Tecnologia e algoritmi di visione artificiale

Tramite la società Finlandese Aarila Dots Oy, abbiamo fatto sviluppare una tecnologia necessaria per fornire un'esperienza eccezionale e misurazioni accurate, basate sulle misurazioni reali seguite dallo standard ISO 8559-1 (designazione della taglia dei vestiti).

Preciso indipendentemente dal tipo di corpo

A differenza della modellazione statistica / dati, Kimay fit è accurato con qualsiasi tipo di forma del corpo.



CERTIFICAZIONI ISO ISO CERTIFICATIONS



CERTIFICAZIONI PRODOTTI PRODUCTS CERTIFICATION



BOOK PRESENTAZIONE DIVISE

UNIFORMS BOOK



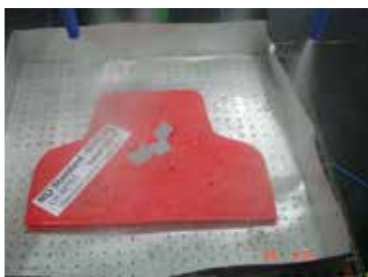

LIVELLO PROTEZIONE

NIJ STANDARD 0101.04



22 LRHV • 40 gr • 1050+50 ft/s



38 Special RN • 158 gr • 850+50 ft/s



9 mm FMJ • 124 gr • 1090+50 ft/s



357 Magnum JSP • 158 gr • 1250+50 ft/s



9 mm FMJ • 124 gr • 1175+50 ft/s



357 Magnum JSP • 158 gr • 1395+50 ft/s



9 mm FMJ • 124 gr • 1400+50 ft/s



44 Mag Lead SWC GC • 240 gr • 1400+50 ft/s



7.62 mm FMJ • 150 gr • 2750+50 ft/s



30-06 AP • 166 gr • 2850+50 ft/s

I

II-A

II

III-A

III

IV



GIUBBINI ANTIPROIEETTILE SPECIFICHE

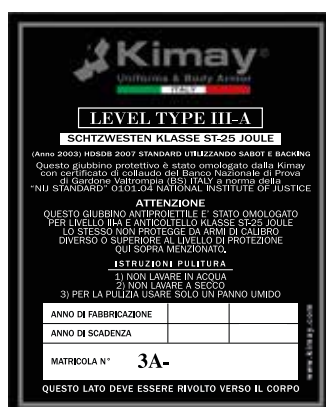

Giubbini antiproiettile Body armour

SOTTOCAMICIA CH

CH BODY ARMOR



Vestina esterna realizzata in misto cotone, leggera e con un ottima vestibilità tramite regolazione con velcro su spalle e fasce sui fianchi.

Dotata di chiusura in velcro nella parte interna inferiore per l'inserimento dei pannelli balistici al fine di escludere sfregamenti fastidiosi al corpo.

Il prolungamento della vestina, che può essere rimovibile viene inserito nei pantaloni come fosse una camicia per prevenirne lo spostamento.

Light outer vest, constructed with a cotton blend.

Featuring Velcro straps at the shoulders and bands at the hips for an excellent fit. Equipped with Velcro fastenings inside the inner lower part where the ballistic panels are placed, avoiding annoying body rubbing.

The vest extension, which is removable, is designed as a shirt and won't be displaced once tucked into the trousers.



BIANCO	NERO	BLU
S - XXL	S - XXL	S - XXL
A GPA32	A GPA23	A GPA33
B GPA34	B GPA24	B GPA35
C GPA40	C GPA77	C GPA39
D GPA50	D GPA48	D GPA49

A ARTEC		0101.04 CLASSE II							
TAGLIA US SIZE	RIFERIMENTO TAGLIA SIZE	CIRCONFERENZA TORACE CHEST	CMQ PROTEZIONE BALISTICA BALISTIC AREA	PESO PANNELLO BALISTICO (KG) PANEL WEIGHT	PESO VESTINA (KG) VEST WEIGHT		PESO TOTALE GPA (KG) TOTAL WEIGHT GPA (KG)		
					SOTTOCAMICIA	ESTERNO CH	SOTTOCAMICIA	ESTERNO CH	
S	42/44	96	2,400	1,000	0,270	0,470	1,27	1,47	
M	46/48	104	2,650	1,200	0,300	0,500	1,50	1,70	
L	50/52	110	2,900	1,300	0,330	0,530	1,63	1,83	
XL	54/56	116	3,250	1,450	0,360	0,560	1,81	2,01	
XXL	58/60	122	3,600	1,600	0,400	0,600	2,00	2,20	

B ARTEC + PARAX		0101.04 CLASSE III-A ANTITAGLIO SHTZWESTEN KLASSE ST 25 JOULE (2003) HOSDB 2007 STANDARD							
TAGLIA US SIZE	RIFERIMENTO TAGLIA SIZE	CIRCONFERENZA TORACE CHEST	CMQ PROTEZIONE BALISTICA BALISTIC AREA	PESO PANNELLO BALISTICO (KG) PANEL WEIGHT	PESO VESTINA (KG) VEST WEIGHT		PESO TOTALE GPA (KG) TOTAL WEIGHT GPA (KG)		
					SOTTOCAMICIA	ESTERNO CH	SOTTOCAMICIA	ESTERNO CH	
S	42/44	96	2,400	1,600	0,270	0,470	1,87	2,07	
M	46/48	104	2,650	1,700	0,300	0,500	2,00	2,20	
L	50/52	110	2,900	1,900	0,330	0,530	2,23	2,43	
XL	54/56	116	3,250	2,100	0,360	0,560	2,46	2,66	
XXL	58/60	122	3,600	2,300	0,400	0,600	2,70	2,90	

ESTERNO S/T CH CERNIERA

S/T OUTDOOR BODY ARMOR



Vestina realizzata in Cordura Du-Pont nei colori blu e nero e in misto cotone poliestere nelle altre colorazioni, grazie alla cerniera centrale può essere indossato come un gilet con estrema rapidità pur mantenendo la piastra di protezione balistica anteriore in un unico pannello. Regolazione con velcro su spalle e fasce sui fianchi.

Vest constructed from Cordura Du-Pont. Comes in blue and black- cotton polyester blends available in other colors. Vest is designed as a shirt for quick donning and doffing, while keeping the ballistic front plate in a single panel thanks to the central zipper. There are Velcro straps at shoulders and bands at hips to give it a better fit.



BLU	NERO	GIALLO HV
S - XXL	S - XXL	S - XXL
A GPA71	A GPA70	A GPA72
B GPA74	B GPA73	B GPA75
C GPA42	C GPA41	C GPA43
D GPA52	D GPA51	D GPA53

C THOR		0101.04 CLASSE III-A						
TAGLIA US SIZE	RIFERIMENTO TAGLIA SIZE	CIRCONFERENZA TORACE CHEST	CMQ PROTEZIONE BALISTICA BALISTIC AREA	PESO PANNELLO BALISTICO (KG) PANEL WEIGHT	PESO VESTINA (KG) VEST WEIGHT		PESO TOTALE GPA (KG) TOTAL WEIGHT GPA (KG)	
					SOTTOCAMICIA	ESTERNO CH	SOTTOCAMICIA	ESTERNO CH
S	42/44	96	2,400	1,600	0,270	0,470	1,87	2,07
M	46/48	104	2,650	1,750	0,300	0,500	2,05	2,25
L	50/52	110	2,900	1,900	0,330	0,530	2,23	2,43
XL	54/56	116	3,250	2,100	0,360	0,560	2,46	2,66
XXL	58/60	122	3,600	2,400	0,400	0,600	2,80	3,00

D THOR + PARAX		0101.04 TYPE III-A ANTITAGLIO SCHTZWESTEN KLASSE ST 25 JOULE (2003) HOSDB 2007 STANDARD						
TAGLIA US SIZE	RIFERIMENTO TAGLIA SIZE	CIRCONFERENZA TORACE CHEST	CMQ PROTEZIONE BALISTICA BALISTIC AREA	PESO PANNELLO BALISTICO (KG) PANEL WEIGHT	PESO VESTINA (KG) VEST WEIGHT		PESO TOTALE GPA (KG) TOTAL WEIGHT GPA (KG)	
					SOTTOCAMICIA	ESTERNO CH	SOTTOCAMICIA	ESTERNO CH
S	42/44	96	2,400	2,000	0,270	0,470	2,27	2,47
M	46/48	104	2,650	2,200	0,300	0,500	2,50	2,70
L	50/52	110	2,900	2,400	0,330	0,530	2,73	2,93
XL	54/56	116	3,250	2,700	0,360	0,560	3,06	3,26
XXL	58/60	122	3,600	2,950	0,400	0,600	3,35	3,55

MONDIALPOL

MONDIALPOL BODY ARMOR



Il modello ideale per il servizio su furgoni blindati e automezzi, per la sua leggerezza e compattezza permette di guidare e muoversi senza impedimenti. Grazie alle regolazioni con velcro sulle spalle ed elastico sui fianchi offre il miglior compromesso tra protezione e vestibilità.

The ideal model to wear for service on armored vans and vehicles thanks to its light weight and compact design, this armor allows easy moving and driving without hindrance. Velcro straps at the shoulders and elastic bands at the waist allow for both comfort and protection.



VERSIONE MOLLE - MP

BLU

	S - XL	XXL-XXXL
C	GPA46	GPA46XX
D	GPA60	GPA60XX

NERO

	S - XL	XXL-XXXL
C	GPA81	GPA81XX
D	GPA82	GPA82XX

VERDE

	S - XL	XXL-XXXL
C	GPA78	GPA78XX



C THOR		0101.04 TYPE III-A				
TAGLIA US SIZE	RIFERIMENTO TAGLIA SIZE	CIRCONFERENZA TORACE CHEST	CMQ PROTEZIONE BALISTICA BALISTIC AREA	PESO PANNELLO BALISTICO (KG) PANEL WEIGHT	PESO VESTINA (KG) VEST WEIGHT	PESO TOTALE GPA (KG) TOTAL WEIGHT
S	42/44	86/94	2,750	1,800	0,460	2,26
M	46/48	92/102	3,050	2,000	0,490	2,49
L	50/52	100/108	3,300	2,200	0,520	2,72
XL	54/56	110/114	3,600	2,400	0,530	2,93
XXL	58/60	112/120	4,000	2,600	0,540	3,14
XXXL	62/64	120/128	4,350	2,800	0,570	3,37

D THOR + PARAX		0101.04 TYPE III-A ANTITAGLIO SCHTZWESTEN KLASSE ST 25 JOULE (2003) HOSDB 2007 STANDARD				
TAGLIA US SIZE	RIFERIMENTO TAGLIA SIZE	CIRCONFERENZA TORACE CHEST	CMQ PROTEZIONE BALISTICA BALISTIC AREA	PESO PANNELLO BALISTICO (KG) PANEL WEIGHT	PESO VESTINA (KG) VEST WEIGHT	PESO TOTALE GPA (KG) TOTAL WEIGHT
S	42/44	86/94	2,750	2,200	0,460	2,66
M	46/48	92/102	3,050	2,400	0,490	2,89
L	50/52	100/108	3,300	2,700	0,520	3,32
XL	54/56	110/114	3,600	2,900	0,530	3,43
XXL	58/60	112/120	4,000	3,200	0,540	3,74
XXXL	62/64	120/128	4,350	3,500	0,570	4,07

CERNIERA DS COMFORTEC

DS COMFORTEC BODY ARMOR



Giubbino di nuova concezione, facile da indossare grazie alla cerniera centrale, che mantiene lo stesso la piastra di protezione balistica anteriore in un unico pannello. Regolabile con velcro su spalle e fasce sui fianchi. Dotato sulla parte frontale di 4 pannelli rimovibili per l'attacco con velcro di accessori e di una striscia su schiena per eventuali personalizzazioni.

New concept body armor, easy to wear thanks to the central zipper that also keeps the front ballistic plate in a single panel. Featuring adjustable Velcro at the shoulders and bands at the hips, as well as four removable panels on the front side to place Velcro-strapped accessories and a strip on the back for any possible



	BLU	
	S - XXL	LONG
C	GPA28	GPA29
D	GPA56	GPA57

	NERO	
	S - XXL	LONG
	GPA30	GPA31
	GPA54	GPA55

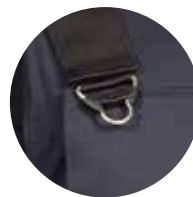

Ganci per attacco borsoni



C	THOR	0101.04 CLASSE III-A			
TAGLIA US SIZE	RIFERIMENTO TAGLIA SIZE	CMQ PROTEZIONE BALISTICA BALISTIC AREA	PESO PANNELLO BALISTICO (KG) PANEL WEIGHT	PESO VESTINA (KG) VEST WEIGHT	PESO TOTALE GPA (KG) TOTAL WEIGHT
S/XXL	48/60	2,700	1,750	0,680	2,43
LONG	62/68	2,900	1,900	0,730	2,63

D	THOR + PARAX	0101.04 CLASSE III-A ANTITAGLIO SHTZWESTEN KLASSE ST 25 JOULE (2003) HOSDB 2007 STANDARD			
TAGLIA US SIZE	RIFERIMENTO TAGLIA SIZE	CMQ PROTEZIONE BALISTICA BALISTIC AREA	PESO PANNELLO BALISTICO (KG) PANEL WEIGHT	PESO VESTINA (KG) VEST WEIGHT	PESO TOTALE GPA (KG) TOTAL WEIGHT
S/XXL	48/60	2,700	2,150	0,680	2,83
LONG	62/68	2,900	2,300	0,730	3,03

CORDURA CERNIERA

CORDURA BODY ARMOR



Vestina realizzata in Cordura Du-Pont, con regolazione velcro su spalle e fibbie regolabili su fianchi. Giubbino antiproiettile per uso esterno, indicato per i servizi di pronto intervento. Rapido da indossare, come se fosse un gilet, si adegua alle più svariate corporature pur essendo prodotto in taglia unica (fino alla tg. XXL). Disponibile anche in taglia EXTRA su richiesta.

Vest is made of Cordura Du-Pont. Features adjustable Velcro straps at the shoulders and adaptable buckles at the hips. Bulletproof vest for outdoor use only, recommended only for emergency services. The vest can suit a wide range of different body sizes when even produced in only one size. Extra sizes are available upon request.



BLU

S - XXL **EXTRA**
C GPA45 GPA45EXTRA
D GPA59 GPA59EXTRA

NERO

S - XXL **EXTRA**
C GPA44 GPA44EXTRA
D GPA58 GPA58EXTRA

VERDE

S - XXL **EXTRA**
C GPA69 GPA69EXTRA
D GPA68 GPA68EXTRA



C THOR		0101.04 TYPE III-A			
TAGLIA US SIZE	RIFERIMENTO TAGLIA SIZE	CMQ PROTEZIONE BALISTICA BALISTIC AREA	PESO PANNELLO BALISTICO (KG) PANEL WEIGHT	PESO VESTINA (KG) VEST WEIGHT	PESO TOTALE GPA (KG) TOTAL WEIGHT
S/XXL	48/60	2,900	1,900	0,870	2,77
EXTRA	62/70	3,700	2,400	1,000	3,40

D THOR + PARAX		0101.04 TYPE III-A ANTITAGLIO SCHKZWESTEN KLASSE ST 25 JOULE (2003) HOSDB 2007 STANDARD			
TAGLIA US SIZE	RIFERIMENTO TAGLIA SIZE	CMQ PROTEZIONE BALISTICA BALISTIC AREA	PESO PANNELLO BALISTICO (KG) PANEL WEIGHT	PESO VESTINA (KG) VEST WEIGHT	PESO TOTALE GPA (KG) TOTAL WEIGHT
S/XXL	48/60	2,900	2,300	0,870	3,17
EXTRA	62/70	3,700	2,900	1,000	3,20

P/C CON ACCESSORI FISSI

BODY ARMOR WITH ACCESSORIES HOLDER



Vestina realizzata in poliestere cotone, con regolazione velcro sulle spalle e velcri regolabili sui fianchi. Fondina, porta radio e porta caricatori cuciti sulla parte frontale.

Giubbino antiproiettile per uso esterno, indicato per i servizi di pronto intervento.

Prodotto in taglia unica (fino alla XXL).

Disponibile anche in taglia EXTRA su richiesta.

Vest is made of polyester cotton. Features adjustable Velcro straps at the shoulders and adaptable buckles at the hips. Gun holster, magazine, and radio holders are attached to the front. Bulletproof vest is for outdoor use only and recommended for emergency services. Produced in one size only, up to XXL. Extra sizes are available upon request.



BLU

	S - XXL	EXTRA
C	GPA79	GPA79EXTRA
D	GPA67	GPA67EXTRA

NERO

	S - XXL	EXTRA
C	GPA76	GPA76EXTRA
D	GPA64	GPA64EXTRA



C	THOR	0101.04 TYPE III-A			
TAGLIA US SIZE	RIFERIMENTO TAGLIA SIZE	CMQ PROTEZIONE BALISTICA BALISTIC AREA	PESO PANNELLO BALISTICO (KG) PANEL WEIGHT	PESO VESTINA (KG) VEST WEIGHT	PESO TOTALE GPA (KG) TOTAL WEIGHT
S/XXL	48/60	2,900	1,900	0,670	2,57
EXTRA	62/70	3,700	2,400	0,880	3,28

D	THOR + PARAX	0101.04 TYPE III-A ANTITAGLIO SCHTZWESTEN KLASSE ST 25 JOULE (2003) HOSDB 2007 STANDARD			
TAGLIA US SIZE	RIFERIMENTO TAGLIA SIZE	CMQ PROTEZIONE BALISTICA BALISTIC AREA	PESO PANNELLO BALISTICO (KG) PANEL WEIGHT	PESO VESTINA (KG) VEST WEIGHT	PESO TOTALE GPA (KG) TOTAL WEIGHT
S/XXL	48/60	2,900	2,300	0,670	2,97
EXTRA	62/70	3,700	2,900	0,880	3,78

TATTICO SISTEMA MOLLE

MOLLE TACTICAL BODY ARMOR



Vestina realizzata in Cordura Du-Pont nel colore nero e in misto cotone poliestere nel colore sabbia. Con spalline, collo e cerniera frontale, indicata in tutte le situazioni in cui è richiesta la massima superficie protetta. Dotata di sistema molle su entrambi i lati che permette di applicare una vasta gamma di accessori. Con tasca anteriore e posteriore per l'inserimento della piastra. (raggiungimento livello III, IIIPLUS e IV).

Vest comes in Cordura Du-Pont in black color and for tan color mixed polyester cotton. Features front zipped shoulders and neck, and recommended whenever maximum body protection is required.

A molle system on both sides allows the wearer to apply a wide range of accessories, with front and back pockets to place the hard armor plates. (III, IIIPLUS and IV Threat Level).



NERO

S - XXL

C GPA47

D GPA61

SABBIA

S - XXL

C GPA62

D GPA65



C THOR		0101.04 CLASSE III-A				
TAGLIA US SIZE	RIFERIMENTO TAGLIA SIZE	CIRCONFERENZA TORACE CHEST	CMQ PROTEZIONE BALISTICA BALISTIC AREA	PESO PANNELLO BALISTICO (KG) PANEL WEIGHT	PESO VESTINA (KG) VEST WEIGHT	PESO TOTALE GPA (KG) TOTAL WEIGHT
S	42/44	96	4,150	2,700	1,100	3,800
M	46/48	104	4,800	3,100	1,200	4,300
L	50/52	110	5,500	3,600	1,250	4,850
XL	54/56	116	5,950	3,900	1,300	5,200
XXL	58/60	122	7,400	4,800	1,400	6,200

D THOR + PARAX		0101.04 CLASSE III-A ANTITAGLIO SHTZWESTEN KLASSE ST 25 JOULE (2003) HOSDB 2007 STANDARD				
TAGLIA US SIZE	RIFERIMENTO TAGLIA SIZE	CIRCONFERENZA TORACE CHEST	CMQ PROTEZIONE BALISTICA BALISTIC AREA	PESO PANNELLO BALISTICO (KG) PANEL WEIGHT	PESO VESTINA (KG) VEST WEIGHT	PESO TOTALE GPA (KG) TOTAL WEIGHT
S	42/44	96	4,150	3,100	1,100	4,200
M	46/48	104	4,800	3,600	1,200	4,800
L	50/52	110	5,500	4,100	1,250	5,350
XL	54/56	116	5,900	4,400	1,300	5,700
XXL	58/60	122	7,400	5,500	1,400	6,900

TATTICO
PRODOTTO PER
GRUPPI SPECIALI
E POLIZIA



PANNELLI BALISTICI

BALISTIC PANELS



PIA9



PIA35 80 STRATI



PIA20 72 STRATI



- G** Piastra in fibroceramica tripla curva 255/305 - peso 2,8 kg - NIJ STANDARD 0101.03 TYPE IV
255/305 triple curve ceramic-fiber- ceramic/kevlar- weight kg 2,8
- F** Piastra Dyneema hb 26 termopressato 80 strati - peso 1,5 kg - NIJ STANDARD 0101.04 TYPE III PLUS
Heat-pressed 80 layers Dyneema plate HB 26- weight Kg 1,5
- E** Piastra Dyneema HB 26 termopressato 72 strati - peso 1,3 kg - NIJ STANDARD 0101.04 TYPE III
Heat-pressed 72 layers Dyneema plate HB 26- weight Kg 1,3

VALIGETTA 24H ANTIPROIETTILE

24H BULLETPROOF BRIEFCASE



Realizzata in Cordura colore nero con tasche porta documenti e porta biro, completa di tracolla; con tasca interna per alloggiare piastra Livello III - IV (255/305). Pacchetto balistico realizzato in Thor 25 strati omologato con certificato del Banco Nazionale di Prova (ITALIA) n. 38 bal AG/vp del 23/11/2012 secondo la normativa NIJ STANDARD 01/01/04 TYPE III-A.

Briefcase made of black Cordura. Features pockets for documents and pens, as well as a shoulder strap and inner pocket to place an III-IV level ballistic panel. Ballistic panel made from 25 Thor layers approved by the National Italian Proof certificate. [nr. 38 bla AG/vp dated 23/11/2012 according to NJ STANDARD 01/01/04 TYPE III-A].

DIMENSIONI/SIZES:

Pacchetto balistico aperto/panel size/

Open panel size: 48 x 100 cm.

Area di protezione/balistic area/

Protected surface: 5225 cmq

Peso pacchetto/panel weight

Panel weight: 3,050 Kg

Peso totale borsa/total weight

Briefcase weight: 3,590



GPA80

BORSA PORTA GPA

GPA BAGS



BOR1 Blu
BOR2 Nera



BOR1G Blu grande
BOR2G Nera grande



BOR21 Borsa nera
con porta badge

ESEMPI DI PERSONALIZZAZIONI e ACCESSORI

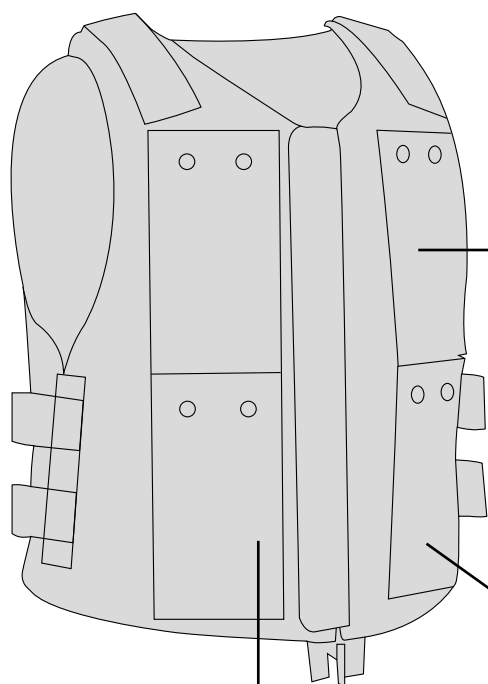

TAC11
Porta pistola per 98F



TAC23
Porta pistola per 84F

TAC12
Porta radio



TAC13
Porta caricatore doppio

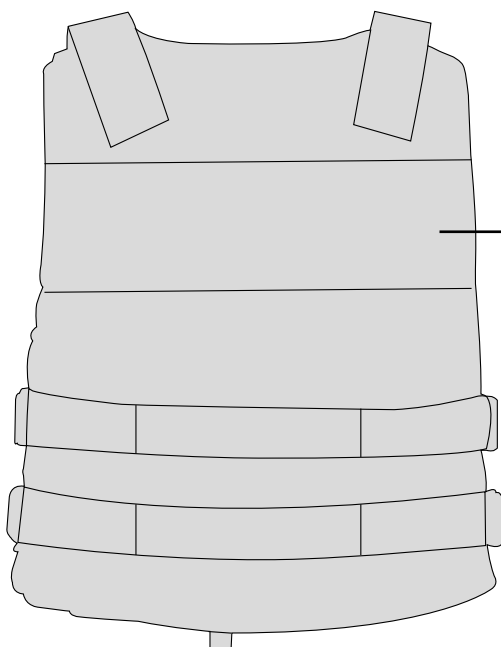

La **qualità** si ottiene
passo dopo **passo**

Anfibi Boots





ANF111L

Anfibi morbido e leggerissimo realizzato in pelle pieno fiore con inserto in Cordura Du Pont sfoderata, allacciatura rapida con cerniera YKK e sicura in velcro, doppi lacci per una perfetta regolazione con clips di chiusura; con soletta anti perforazione in Kevlar e suola Vibram Roccia cucita a Blake. Realizzato in Italia.

Comfortable and light boot made from the highest quality leather. Features unlined Cordura Du-Pont inserts, quick fastening with YKK zipper and Velcro strap, double laces and closing clips for a perfect fit. Kevlar anti-perforation insole and a Blake sewed Vibram sole. Made in Italy.

Taglie/sizes: da 36 a 47

Certificazione EN ISO 20347:2012



ANF999

Anfibi morbido e leggero realizzato in pelle pieno fiore con inserto in Cordura Du Pont, foderato con tessuto Wind-Tex accoppiato con membrana idrorepellente e traspirante, allacciatura rapida con occhielli e ganci; con soletta anti perforazione in Kevlar e suola Vibram Roccia cucita a Blake. Realizzato in Italia.

Comfortable and light boot made from the highest quality leather. Features Cordura Du-Pont inserts, Wind-Tex fabric lining, waterproof and breathable membrane, and eyelets and hooks for a quick fastening. Kevlar anti-perforation insole and a Blake sewed Vibram sole. Made in Italy.

Taglie/sizes: da 36 a 47

Certificazione EN ISO 20347:2012



ANF006/L

Anfibi tutta stagione realizzato in pelle pieno fiore con inserti in Cordura Du Pont, foderato con tessuto Wind-Tex accoppiato con membrana idrorepellente e traspirante, allacciatura rapida con occhielli e ganci; con soletta in Kevlar anti perforazione e suola Vibram Cube. Realizzato in Italia.

All season boots made from the highest quality leather. Features Cordura Du-Pont inserts, Wintex fabric lining, waterproof and breathable membrane, and eyelets and hooks for a quick fastening. Kevlar anti-perforation insole and a Vibram Cube sole. Made in Italy.

Taglie/sizes: da 38 a 47

Certificazione EN ISO 20347:2012





ANF901LCH

Scarpa tattica tutta stagione realizzata in pelle pieno fiore con inserti in Cordura Du Pont, foderata in vitello e tessuto Wind-Tex accoppiato con membrana idrorepellente e traspirante; con soletta in Kevlar anti perforazione e suola Vibram Cube. Realizzata in Italia.

All season boots made from the highest quality leather. Features Cordura Du-Pont inserts, calf and Wind-Tex fabric lining, waterproof and breathable membrane, Kevlar anti-perforation insole and a Vibram Cube sole. Made in Italy.

Taglie/sizes: da 38 a 47

Certificazione EN ISO 20347:2012



ANF005

Anfibio tutta stagione leggerissimo realizzato in pelle pieno fiore con inserti sintetici e collo imbottito, foderato con membrana idrorepellente e traspirante; con soletta anti perforazione e suola antiscivolo ed antifiama. Realizzato in Ucraina.

All season boots made from the highest quality leather. Features synthetic inserts, a padded collar, a waterproof and breathable membrane lining, anti-perforation insole, as well as slip resistant, flame-retardant soles. Made in Ukraine.

Taglie/sizes: da 35 a 48

Certificazione EN ISO 20347:2012



TALAN

NEW!

ganci in metallo

stringhe piatte

tessuto superiore



COMING SOON!



ANF800L

Scarpa classica tutta stagione in pelle pieno fiore foderata in maialino, con soletta in Kevlar anti perforazione e suola in gomma TPU antishock ed antiscivolo. Realizzata in Italia.

Classic all-season shoe made from the highest quality leather. Features piglet lining, Kevlar anti-perforation insole, TPU rubber shock-absorbent and slip-resistant sole. Made in Italy.

Taglie/sizes: da 38 a 46

Certificazione EN ISO 20347:2004



ANF903

Scarpa classica unisex realizzata in pelle pieno fiore con inserti in Cordura Du Pont e soletta ergonomica in gel. Realizzata in Italia.

Classic unisex shoe made from the highest quality leather. Features Cordura Du-Pont inserts and a gel ergonomic sole. Made in Italy.

Taglie/sizes: da 35 a 49



ANF901LP

Versione antinfortunistica della scarpa tattica ANF901LCH, con puntale in composito; classe di protezione S3. Realizzata in Italia.

Safety shoe, produced with the same tactical features as ANF901LCH tactical shoe: Composite toecap and 53 class protection. Made in Italy.

Taglie/sizes: da 36 a 47

Certificazione EN ISO 20345:2011



ANF999/P

Versione antinfortunistica del modello ANF999, con puntale in composito; classe di protezione S3. Realizzato in Italia.

Safety shoe, produced with the same features as ANF999: Composite toecap and 53 class protection. Made in Italy.

Taglie/sizes: da 37 a 46

Certificazione EN ISO 20346:2014

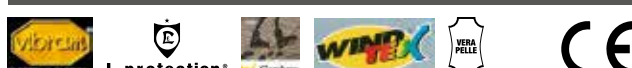

ANF005/P

Versione antinfortunistica del modello ANF005, con puntale in composito; classe di protezione S3. Realizzato in Ucraina.

Safety shoe, produced with the same features as ANF005: Composite toecap, 53-class protection. Made in Ukraine.

Taglie/sizes: da 35 a 48

Certificazione EN ISO 20345:2011





ANF002

Calzatura bassa in tessuto con fili di nylon e inserti in microfibra colore nero/grigio, con puntale in composito e lamina non metallica, soletta estraibile antishock, suola antistatica e antiolio.

Low ankle cut shoe made from nylon and inserts in black/gray microfiber removable insole with Shock Absortion properties, composite toecap and non-metallic midsole.

Taglie/sizes: da 35 a 48

Certificazione EN ISO 20345:2011



SSRC174

Calzatura bassa in pelle pieno fiore colore nero con inserti rifrangenti, puntale in acciaio e lamina non metallica, linguetta e caviglia imbottite, soletta estraibile traspirante e antistatica, e suola poliuretano bidensità.

Low ankle cut shoe made from the highest quality black leather. Features reflective inserts, steel toe cap and non-metallic plate, padded ankle and latch; removable, breathable and antistatic insole, and double density polyurethane sole.

Taglie/sizes: da 36 a 47

Certificazione EN ISO 20345:2011



PPVL100

Calzatura alta in pelle pieno fiore colore nero con linguetta imbottita, puntale in composito e lamina in acciaio, imbottitura alla caviglia, soletta estraibile traspirante e antistatica, e suola in poliuretano bidensità. Classe protezione S3.

High ankle cut shoe made from the highest quality black leather. Features a padded latch, composite toecap and steel plate, padded ankle; removable, breathable and antistatic insole, and double density polyurethane sole.

Taglie/sizes: da 38 a 47

Certificazione EN ISO 20345:2011





FEEL THE EVOLUTION





Berretti Caps



CAP1
blu

BERRETTO CLASSICO

Berretto classico tipo Carabiniere realizzato in lana con visiera giapponese, fascia millerighe, soggolo nero e bottoni oro.

CLASSIC CAP

Classic police cap constructed of wool. Features a Japanese peak, striped band, black wimple and golden buttons.



CAP33
nero



CAP46
grigio



CAP42
verde



CAP2
blu

BERRETTO 8 PUNTE

Berretto classico 8 punte realizzato in lana con visiera giapponese, fascia millerighe, soggolo nero e bottoni oro.

8 TIPS CAP

Classic cap constructed of wool. Features 8 tips, a Japanese peak, striped band, black wimple and golden buttons.



CAP30
nero



CAP1/D
blu

BERRETTO DONNA

Berretto donna tipo Maema realizzato in lana con fascia millerighe.

WOMEN'S CAP

Women's cap, constructed of wool. Features a Maema design, striped band hatband.



CAP2/D
nero

CORDONI PER BERRETTI CLASSICI

CLASSIC CAPS CORD



SOG23



CH38



CH37



SOG04



CH36



CH67



SOG22

SOGGOLI PER BERRETTI CLASSICI

CLASSIC CAPS WIMPLES



SOG01

Soggolo per cappello colore oro 1 riga verde



SOG02

Soggolo per cappello colore oro 1 riga nera



SOG03

Soggolo per cappello colore oro



SOG06

Soggolo per cappello colore argento 1 riga nera



SOG07

Soggolo per cappello colore argento

GALLONCINI

CLASSIC CAPS WIMPLES



SOG10



SOG11



SOG16



SOG12



SOG13



SOG15



SOG14



CAP40

blu

CAPPELLINO COTONE

Cappellino modello baseball U.S. 5 pannelli realizzato in 100% cotone con chiusura fibbia in pvc; taglia unica. Colore blu.

COTTON CAP

Blue U.S. baseball cap made from 100% cotton. Features 5 panels and PVC bucket clasp. One size only.



CAP4

nero



CAP22

blu

CAPPELLINO POLIESTERE

Cappellino modello baseball U.S. 5 pannelli realizzato in 100% poliestere con chiusura fibbia in pvc; taglia unica.

POLYESTER CAP

U.S baseball cap constructed from 100% polyester. Features 5 panels and PVC buckle clasp. One size only.



CAP38

nero



CAP44

blu

BERRETTO

Berretta modello U.S. realizzato in 100% lana idrorepellente, taglia unica.

BEANIE

U.S. design beanie made from 100% waterproof wool. One size only.



CAP55

nero



CAP54

blu

BERRETTO

Berretta modello Wind realizzato in 100% poliestere, taglia unica.

WIND BEANIE

Wind design beanie constructed from 100% polyester. One size only.



CAP17

blu

BASCO

Basco tipo Boina versione lusso realizzato in 100% lana, bordo in gros grain nero e laccetti.

BASQUE BERET

Luxury Basque beret. Comes in a Boina design. Constructed of 100% wool. Features black grosgrain hems and laces.



ACV47

blu



ACV47N

nero

SCALDACOLLO

Collare in micropile in 100% poliestere con cordoncino di regolazione, taglia unica.

Micro fleece neck warmer, constructed of 100% polyester. Features an adjustable draw cord. One size only.



CAP21

bordeaux

CAP18

royal

CAP19

verde scuro

CAP16/A

nero



Giubbotti Jackets

ПОЛИЦ

BOMBER TEPAS

TEPAS BOMBER JACKET



GIU8

blu

Bomber modello U.S. realizzato in 100% poliestere con membrana impermeabile, con interno trapuntato staccabile per uso estivo; dotato di spalline e due tasche con bottoni oro chiuse con velcro, porta distintivo/badge su petto sinistro, polsi regolabili con velcro.

U.S. designed bomber jacket made of 100% polyester. Features a waterproof membrane, quilted inner lining which can be removed for summer comfort, shoulder straps, two Velcro-fastened pockets with golden buttons, plate/badge holder on the left pectoral and Velcro-adjustable cuffs.



GIU7

nero

taglie/sizes

XS	S	M	L	XL	XXL	XXXL	XXXXL
40/42	44/46	48/50	52/54	56/58	60/62	64/66	68/70

GIUBBINO DS CORDURA

DS CORDURA JACKET

giubbino operativo



GIU20

blu

Giubbino realizzato in Cordura Du Pont, con interno trapuntato staccabile per uso estivo e collo foderato con morbido tessuto antigraffio; dotato di spalline, porta distintivo/badge su petto sinistro, taschino multiuso su petto destro, ampie tasche laterali con bottoni a pressione e aperture laterali con zip per regolazione fondina.

Made of Cordura Du Pont. Features removable inner quilting for summer comfort, soft scratchproof collar lining, shoulder straps, plate/badge holder on the left pectoral, multi-purpose pocket on the right pectoral, wide side pockets with snap buttons and zippered sides to adjust the gun holster.



GIU21

nero

taglie/sizes

XS	S	M	L	XL	XXL	XXXL	XXXXL
40/42	44/46	48/50	52/54	56/58	60/62	64/66	68/70

GIUBBINO DS TEPAS

DS TEPAS JACKET

giubbino operativo



GIU27

blu

Giubbino realizzato in 100% poliestere con membrana impermeabile, con interno trapuntato staccabile per uso estivo e collo foderato con morbido tessuto antigraffio; dotato di spalline, porta distintivo/badge su petto sinistro, taschino multiuso su petto destro, ampie tasche laterali con bottoni a pressione e aperture laterali con zip per regolazione fondina.

Made from 100% polyester. Features a waterproof membrane, removable lining for summer comfort, soft scratchproof collar lining, shoulder straps, plate/badge holder on the left pectoral, multi-purpose pockets on the right pectoral, wide side pockets with snap buttons and zippered sides to adjust the gun holder.



GIU28

nero

taglie/sizes

XS	S	M	L	XL	XXL	XXXL	XXXXL
40/42	44/46	48/50	52/54	56/58	60/62	64/66	68/70

GIACCA OPERATIVA

con trapuntato staccabile

OPERATIONAL JACKET

with removable quilted lining



GIA41

blu

Giacca a vento modello operativo realizzata in 100% poliestere tre strati, completamente termosaldata con tenuta di 10.000 colonne d'acqua, con interno trapuntato staccabile per uso estivo; con due tasche nascoste su petto, quattro tasche multiuso su braccia e gomitiere per inserimento protezioni, polsini regolabili con velcro, cappuccio a scomparsa nel collo.

Windbreaker jacket. Designed for an operational purpose. Constructed with 100% 3-layer thermic-welded polyester. Water resistance up to 10.000 water columns. Features two hidden pockets on the chest, four multi-purpose pockets on the arms and elbows to hold protective equipment, Velcro-adjustable cuffs and a retractable hood.



GIA42

nero

taglie/sizes

XS	S	M	L	XL	XXL	XXXL	XXXXL
40/42	44/46	48/50	52/54	56/58	60/62	64/66	68/70

GIACCA OPERATIVA

con softshell autoportante

OPERATIONAL JACKET

with freestanding softshell



GIA38

blu

Giacca a vento modello operativo realizzata in 100% poliestere tre strati, completamente termosaldata con tenuta di 10.000 colonne d'acqua; con due tasche nascoste su petto, quattro tasche multiuso su braccia e gomitiere per inserimento protezioni, polsini regolabili con velcro, cappuccio a scomparsa nel collo. Dotato di softshell staccabile ed autoportante con maniche staccabili per utilizzo in mezza stagione (capo venduto anche singolarmente, scheda articolo a pag. 55).

Windbreak jacket. Designed for operational purposes. Made from 100% 3-layer thermic-welded polyester. Water resistance up to 10.000 water columns. Features two hidden pockets on the chest, four multi-use pockets on the arms and elbows to hold protective equipment, Velcro-adjustable cuffs, and a retractable hood. Complete with freestanding removable soft shell and detachable sleeves for mid-season comfort. (Item sold individually, see technical sheet on page 55).



GIA39

nero

taglie/sizes

XS	S	M	L	XL	XXL	XXXL	XXXXL
40/42	44/46	48/50	52/54	56/58	60/62	64/66	68/70

GIACCA PORTIERATO

CARETAKER JACKET

con trapuntato fisso

Giacca a vento realizzata in 100% poliestere con membrana impermeabile, interno trapuntato fisso, tasca nascosta su petto sinistro, due tasche laterali.

Windbreaker jacket constructed of polyester waterproof lining. Hidden pockets on the chest, a left sleeve pocket, and two side pockets.



GIA19

blu

Disponibile anche GIACCA PORTIERATO con interno staccabile

Giacca a vento realizzata in 100% poliestere impermeabile tre strati con interno trapuntato staccabile, con tasca nascosta su petto sinistro e due tasche laterali, con spalline e aperture laterali con zip.

Windbreaker jacket constructed of three layers polyester waterproof lining. With an internal removable wadded jacket, hidden pockets on the chest, a left sleeve pocket, and two side pockets, shoulder straps, zippers on sides to adjust the gun holder.



GIA20

nero

GIA47

blu

GIA48

nero

taglie/sizes

XS	S	M	L	XL	XXL	XXXL	XXXXL
40/42	44/46	48/50	52/54	56/58	60/62	64/66	68/70

GIACCA A VENTO ³/₄ CORDURA

³/₄ CORDURA WINDBREAKER JACKET

con trapuntato staccabile



GIA4

blu



GIA12

nero

Giacca a vento corta modello U.S. realizzata in Cordura Du Pont con interno trapuntato e collo in pelo staccabili per uso estivo; dotata di spalline e due tasche con bottoni oro, porta distintivo/badge su petto sinistro. Aperture laterali con zip per regolazione fondina.

Short windbreaker jacket made from Cordura Du-Pont. Features a U.S. design, inner quilted lining and fur collar that can be removed for summer comfort, shoulder straps, two gold-buttoned pockets, plate/badge holder on the left pectoral, and zippered sides to adjust the gun holder.

taglie/sizes

XS	S	M	L	XL	XXL	XXXL	XXXXL
40/42	44/46	48/50	52/54	56/58	60/62	64/66	68/70

GIACCA A VENTO M65 CORDURA

con trapuntato staccabile

M65 CORDURA WINDBREAKER JACKET

with detachable quilted lining



GIA8

blu

Giacca a vento modello M65 realizzata in Cordura Du Pont con interno trapuntato staccabile per uso estivo; dotata di spalline con velcro, porta distintivo/badge su petto sinistro, cappuccio staccabile nel collo e quattro tasche a soffiato. Polsi regolabili con velcro, cordino per regolazione vita.

Windbreaker jacket made of Cordura Du-Pont. Features an M65 design, quilted silver lining that can be removed for summer comfort, Velcro-strapped shoulders, plate/badge holder on the left pectoral, detachable hood inside the collar, four bellow pockets, Velcro-adjustable cuffs, and a drawstring waist.



GIA2

nero

taglie/sizes

XS	S	M	L	XL	XXL	XXXL	XXXXL
40/42	44/46	48/50	52/54	56/58	60/62	64/66	68/70

GIACCA A VENTO M65 TEPAS

con trapuntato staccabile

M65 TEPAS WINDBREAKER JACKET

with detachable quilted lining



GIA28

blu

Giacca a vento modello M65 realizzata in 100% poliestere con membrana impermeabile, con interno trapuntato staccabile per uso estivo; dotata di spalline con velcro, porta distintivo/badge su petto sinistro, cappuccio staccabile nel collo e quattro tasche a soffietto. Polsi regolabili con velcro, cordino per regolazione vita.

Windbreaker jacket. Made from 100% polyester. Features an M65 design, waterproof membrane, quilted inner lining which can be removed for summer comfort, Velcro-shouldered shoulder, plate/badge holder on the left pectoral, detachable hood inside the collar, four bellow pockets, Velcro-adjustable cuffs, and a drawstring waist.



GIA29

nero

taglie/sizes

XS	S	M	L	XL	XXL	XXXL	XXXXL
40/42	44/46	48/50	52/54	56/58	60/62	64/66	68/70

PARKA TRIPLIO USO

TRIPLE USE PARKA

Parka triplo uso composto da un impermeabile esterno foderato in nylon e da una giacca interna trapuntata con maniche staccabili, con 4 tasche a soffietto e porta badge su petto sinistro.

Triple use parka. Constituted of nylon lined outer raincoat and a quilted inner jacket with detachable sleeves, four bellow pockets, and a badge holder on the left pectoral.



GIA7
blu

PARKA TRIPLIO USO

alta visibilità

TRIPLE USE PARKA

high visibility

Parka bicolore triplo uso alta visibilità in poliestere con tasca porta radio/cellulare su petto destro, due tasche a soffietto, coulisse in vita e cappuccio a scomparsa nel collo; dotato di interno staccabile ed autoportante con maniche staccabili.

Triple-use parka. Comes in two-tone to ensure high visibility. Constructed of polyester.

Features a radio/mobile pocket on the right pectoral, two bellow pockets, a drawstring waist, and a freestanding removable inner lining with detachable sleeves.



GIA2302A
arancione/blu

GIA2302G
giallo/blu

taglie/sizes

S	M	L	XL	XXL
44/46	48/50	52/54	56/58	60/62

RAINJACKET DS TEPAS

DS TEPAS RAINCOAT



MAN31

blu

Giubbino impermeabile realizzato in 100% poliestere accoppiato con membrana in poliuretano foderato in rete, con due tasche laterali e una nascosta su petto sinistro con zip termosaldata, polsini regolabili con velcro, coulisse in vita e cappuccio a scomparsa nel collo.

Waterproof jacket made from 100% polyester. Features a net-lined polyurethane membrane, two side pockets, and a hidden pocket in the left pectoral complete with a thermic-welded grip, Velcro-adjustable cuffs, a drawstring waist, and a detachable hood.



MAN32

nero

taglie/sizes

XS	S	M	L	XL	XXL	XXXL	XXXXL
40/42	44/46	48/50	52/54	56/58	60/62	64/66	68/70

RAINJACKET DS TERMONASTRATO

WATERPROOF JACKET



MAN37

blu

Giubbino impermeabile realizzato in 100% poliestere tre strati, completamente termonastrato con tenuta di 10.000 colonne d'acqua, con due tasche laterali e una nascosta su petto sinistro con zip, polsini regolabili con velcro, coulisse in vita e cappuccio a scomparsa nel collo.

Waterproof jacket. Made from 100% 3-layered thermic-welded polyester. Water resistant up to 10.000 water columns. Features 2 side pockets, a hidden zippered pocket in the left pectoral, a drawstring waist, and a detachable hood.

taglie/sizes

XS	S	M	L	XL	XXL	XXXL	XXXXL
40/42	44/46	48/50	52/54	56/58	60/62	64/66	68/70

GIUBBINO SOFTSHELL

SOFTSHELL JACKET



GIU24

blu



GIU25

nero

Giubbino tecnico realizzato in 95% poliestere e 5% elasthan, con due tasche laterali con zip nascosta termosaldata, polsini regolabili con velcro e coulisse in vita; chiusura centrale impermeabile e collo foderato con morbido tessuto antigraffio, con maniche staccabili per utilizzo in mezza stagione e cappuccio.

Technical jacket made with 95% polyester and 5% elastin. Features two side pockets complete with hidden thermic-welded zipper, Velcro-adjustable cuffs, a drawstring waist, central fastening, soft scratch-resistant fabric lining on the collar, and detachable sleeves for summer comfort.

taglie/sizes

XS	S	M	L	XL	XXL	XXXL	XXXXL
40/42	44/46	48/50	52/54	56/58	60/62	64/66	68/70

IMPERMEABILE SOPRAGIACCA

WATERPROOF OVER- JACKET



GIA37

blu



GIA46

nero

Impermeabile da abito realizzato in 100% poliestere con membrana impermeabile, con interno trapuntato staccabile per uso estivo; tasca nascosta su petto sinistro e due tasche laterali. Bottoni ai polsi per la regolazione.

Jacket worn over suits. Constructed from 100% polyester. Features a waterproof membrane, inner quilted lining which can be removed for summer comfort, hidden pocket on the left pectoral, two side pockets, and button-down cuffs for the best fit.

taglie/sizes

XS	S	M	L	XL	XXL	XXXL	XXXXL
40/42	44/46	48/50	52/54	56/58	60/62	64/66	68/70

IMPERMEABILE US

US RAINCOAT

Impermeabile modello U.S. realizzato in 100% poliestere con membrana impermeabile, termonastrato, con inserti rifrangenti 3M su maniche e su paramontura; cappuccio staccabile e due tasche laterali.

U.S.-designed raincoat. Made from 100% polyester features a waterproof membrane. Features heat-taped seams, reflective inserts on sleeves and placket, detachable hood, and two side pockets.



MAN3
nero



MAN29
blu

COPRIPANTALONE IMPERMEABILE

WATERPROOF CHAPS

Copri pantalone impermeabile realizzato in 100% poliestere con membrana impermeabile con elastico in vita, cerniera ed elastico alle caviglie.

Waterproof chaps made from 100% polyester features a waterproof membrane, elastic waistband and zippered ankles.



MAN34
nero



COP131
blu

taglie/sizes

XS	S	M	L	XL	XXL	XXXL	XXXXL
40/42	44/46	48/50	52/54	56/58	60/62	64/66	68/70

K-WAY WINDBREAKER

K-way impermeabile in 100% nylon, chiusura a zip intera, con due tasche frontali, polsini elastici e cappuccio a scomparsa; possibilità di richiudere la giacca nella tasca destra che diventa una borsetta con zip bilaterale.

Waterproof windbreaker. Constructed from 100% nylon. Features a full zipper, two front pockets, elastic cuffs, and a retractable hood. Windbreaker can be closed inside the right pocket to become a handbag with a bilateral zipper.



BCJU801N

nero



BCJU801

blu

RAINSUIT completo antipioggia

Completo impermeabile anti vento in 100% poliestere; giacca con cappuccio a scomparsa, 2 tasche frontali, polsini elastici e orlo con cordino regolabile; pantaloni con due tasche ed elastico in vita.

Waterproof windbreaker rain suit. Constructed from 100% polyester. Features a retractable hood, two front pockets, elastic cuffs, hem with an adjustable draw cord, and trousers with two pockets and an elastic waistband.



RER225X

blu



RER225XN

nero

taglie/sizes

S	M	L	XL	XXL
44/46	48/50	52/54	56/58	60/62



Operativo Combat

GIACCA CAMICIA OPERATIVA

OPERATIONAL SHORT JACKET



GTC15

blu

Giacca camicia modello operativo realizzata in misto cotone 200 gr.; con due tasche su petto, quattro tasche multiuso su braccia e gomiti per inserimento protezioni, polsini regolabili con velcro, chiusura colletto con velcro per maggiore protezione.

Operational shirt jacket made from a 200g-cotton blend. Features two pockets on the chest, four multi-purpose pockets on the arms and elbows to hold protective equipment, Velcro-adjustable cuffs, and Velcro neck fastening for better protection.



GTC16

nero

taglie/sizes

XS	S	M	L	XL	XXL	XXXL	XXXXL
40/42	44/46	48/50	52/54	56/58	60/62	64/66	68/70

GIACCA TATTICA

TACTICAL JACKET



GTC17

blu



GTC18

nero

Giacca camicia tattica realizzata in misto cotone kansas, con interno trapuntato staccabile per uso estivo; dotata di spalline con bottoni a pressione, velcri per regolazione su maniche e quattro tasche frontali a soffiutto.

Tactical shirt jacket made from a cotton blend. Features a removable inner quilted lining for summer comfort, strap-buttoned shoulder straps, Velcro-adjustable sleeves, and four lined bellow pockets.

taglie/sizes

XS	S	M	L	XL	XXL	XXXL	XXXXL
40/42	44/46	48/50	52/54	56/58	60/62	64/66	68/70

MAGLIA OPERATIVA

COMBAT SHIRT



Maglia tecnica modello militare completamente ignifuga, realizzata con tessuto misto cotone rip-stop sulle maniche e tessuto misto cotone jersey leggerissimo su torace, quattro tasche multiuso su braccia e gomiti per inserimento protezioni, polsini regolabili con velcro.

Technical shirt with a military, fireproof design. Made with rip-stop cotton blend fabric for the sleeves and an extremely light cotton blend jersey for the chest. Features four multi-purpose pockets on the arms and elbows to hold protective equipment, and Velcro-adjustable cuffs.

taglie/sizes

XS	S	M	L	XL	XXL	XXXL	XXXXL
40/42	44/46	48/50	52/54	56/58	60/62	64/66	68/70



Maglioni Sweaters

GILET

VEST

Gilet classico realizzato in misto lana con collo a V.

Classic V-neck vest made from a wool blend.



MGL9
blu



MGL17
nero

CARDIGAN

WOMEN SWEATER

Cardigan da donna in cotone con collo a V e chiusura a 7 bottoni tono su tono.

Women's V-neck sweater constituted of a cotton blend. Features tone on tone buttons.



MGL22
blu

taglie/sizes

XS	S	M	L	XL	XXL	XXXL	XXXXL
40/42	44/46	48/50	52/54	56/58	60/62	64/66	68/70

MAGLIONE

collo a V 100% cotone

JUMPER

100% cotton V neck

Maglione classico realizzato in 100% cotone con collo a V.

Classic V-neck jumper made from 100% cotton.



MGL24

blu

MAGLIONE COLLO A V

senza toppe

V NECK JUMPER

Maglione classico realizzato in misto lana con collo a V senza toppe.

Classic V-neck jumper constituted of a wool blend.



MGL4

nero

MGL3

blu

taglie/sizes

XS	S	M	L	XL	XXL	XXXL	XXXXL
40/42	44/46	48/50	52/54	56/58	60/62	64/66	68/70

MAGLIONE COLLO A V

con toppe

V NECK JUMPER



MGL5

blu



MGL12

verde

MGL6

nero

Maglione operativo realizzato in misto lana con collo a V; dotato di spalline con bottoni oro, rinforzi su gomiti, tasca porta penne su braccio sinistro e porta placca distintivo/badge su petto sinistro.

V-neck operational jumper constructed from a wool blend. Features golden buttons on the shoulder straps, elbow reinforcements, pen pocket on the left arm, and plate/badge holder on the left pectoral.

taglie/sizes

XS	S	M	L	XL	XXL	XXXL	XXXXL
40/42	44/46	48/50	52/54	56/58	60/62	64/66	68/70

MAGLIONE COLLO ZIP

con toppe

ZIP NECK JUMPER



MGL15

blu



MGL21

grigio

MGL14

nero

Maglione operativo realizzato in misto lana con collo a lupetto mezza zip; dotato di spalline con bottoni oro, rinforzi su gomiti, tasca porta penne su braccio sinistro e porta placca distintivo/badge su petto sinistro.

Operational jumper made from a wool blend. Features half-zippered turtleneck, golden buttons on the shoulder straps, elbow reinforcements, pen pocket on the left arm, and plate/badge holder on the left pectoral.

taglie/sizes

XS	S	M	L	XL	XXL	XXXL	XXXXL
40/42	44/46	48/50	52/54	56/58	60/62	64/66	68/70

PILE

FLEECE JUMPER



PIL9
blu



PIL8
nero

Pile modello operativo realizzato in 100% poliestere con collo a lupetto mezza zip; dotato di spalline con bottoni oro, rinforzi su gomiti, tasca porta penne su braccio sinistro e asola cucita per distintivo/badge su petto sinistro.

Operational fleece jumper made from 100% polyester. Features a half-zippered turtleneck, golden buttons on the shoulder straps, elbow reinforcements, pen pockets on the left arm, and a sewn-in loop to hold a plate/badge on the left pectoral.

taglie/sizes

XS	S	M	L	XL	XXL	XXXL	XXXXL
40/42	44/46	48/50	52/54	56/58	60/62	64/66	68/70

INTIMO TERMICO

THERMAL UNDERWEAR



SOT02

nero



SOT01

nero

Maglia termica unisex manica lunga realizzata in poliestere e spandex, morbido e leggero, garantisce calore e traspirabilità, con collo a lupetto per maggiore isolamento.

Pantalone termico unisex realizzato in poliestere e spandex, morbido e leggero, garantisce calore e traspirabilità.

Thermal unisex long-sleeved shirt and pants, made from polyester and spandex. Soft and light while ensuring both warmth and moisture wicking.

taglie/sizes

XS	S	M	L	XL	XXL	XXXL	XXXXL
40/42	44/46	48/50	52/54	56/58	60/62	64/66	68/70



Camicie Shirts



CAMICIA GUARDIA mod. GG

GG SHIRT



CAM10
manica lunga



CAM9
manica corta

Camicia modello guardia realizzata in misto cotone; dotata di spalline, due tasche sul petto con alette a una punta, bottoni neri e asola cucita per distintivo/badge su petto sinistro. Colore azzurro.

Guard shirt, constructed from a cotton blend. Features shoulder straps, two single-pointed flap pockets on the chest, black buttons, and a sewn-in loop to hold plate/badge on left pectoral. Comes in light blue.

taglie/sizes

XS	S	M	L	XL	XXL	XXXL	XXXXL
36/37	38/39	40/41	42/43	44/45	46/47	48/49	50/51

CAMICIA GUARDIA mod. UB

UB SHIRT



CAM50
manica lunga



CAM51
manica corta

Camicia guardia modello UB realizzata in misto cotone; dotata di spalline, due tasche sul petto con alette a tre punte, bottoni in tinta e asola cucita per distintivo/badge su petto sinistro. Colore azzurro.

UB guard shirt with a UB design. Made from a cotton blend. Features shoulder straps, two pockets with three-pointed flaps on the chest, matching buttons, and a sewn-in loop to hold plate/badge on the left pectoral. Comes in light blue.

taglie/sizes

XS	S	M	L	XL	XXL	XXXL	XXXXL
36/37	38/39	40/41	42/43	44/45	46/47	48/49	50/51

CAMICIA GUARDIA mod. U.S.

U.S. SHIRT



CAM54/IMP
blu/bk



CAM70
bianca

CAM13/IMP
blu

CAM17/IMP
nera

Camicia guardia manica corta modello U.S. realizzata in misto cotone; dotata di spalline e due tasche sul petto con alette a tre punte, con bottoni oro, chiusura centrale con zip nascosta e asola cucita per distintivo/badge su petto sinistro.

Short-sleeved guard shirt in a U.S. design. Made from a cotton blend. Features shoulder straps, two pockets on the chest with three-pointed flaps, gold buttons, hidden zipper for front fastening, and a sewn-in loop to hold badge/plate on the left pectoral.

taglie/sizes

XS	S	M	L	XL	XXL	XXXL	XXXXL
36/37	38/39	40/41	42/43	44/45	46/47	48/49	50/51

CAMICIA GUARDIA mod. U.S. U.S. SHIRT



CAM55/IMP
blu/bk

Camicia guardia manica lunga modello U.S. realizzata in misto cotone; dotata di spalline e due tasche sul petto con alette a tre punte con bottoni oro, chiusura centrale con zip nascosta e asola cucita per distintivo/badge su petto sinistro.

Long-sleeved watch guard shirt in a U.S. design. Made from a cotton blend. Features shoulder straps, two pockets on the chest with three-pointed flaps, gold buttons, hidden zipper for front fastening, and a sewn-in loop to hold badge/plate on the left pectoral.



CAM18/IMP
nera

CAM14/IMP
blu

CAM71
bianca

taglie/sizes

XS	S	M	L	XL	XXL	XXXL	XXXXL
36/37	38/39	40/41	42/43	44/45	46/47	48/49	50/51

CAMICIA CLASSICA mod. GH

CLASSIC SHIRT



CAM30
manica corta

CAM32
manica corta



CAM31
manica lunga

CAM33
manica lunga

Camicia classica da abito realizzata in 97% cotone 3% elasthan, con bottoni in tinta. Disponibile a manica lunga e corta.

Classic shirt suitable for suits. Made with 97% cotton and 3% elasthan. Features matching buttons. Both long and short-sleeved sizes are available.

taglie/sizes

XS	S	M	L	XL	XXL	XXXL	XXXXL
36/37	38/39	40/41	42/43	44/45	46/47	48/49	50/51

CAMICIA CLASSICA DONNA

CLASSIC WOMEN'S SHIRT



CAM64
manica lunga



CAM69
manica corta

Camicia donna da abito realizzata in 100% cotone, con collo aperto e bottoni in tinta. Disponibile a manica lunga e corta.

Classic woman's shirt that is suitable for dresses. Made from 100% cotton. Features an open collar. Both long and short-sleeved sizes are available.

taglie/sizes

XXS	XS	S	M	L	XL	XXL	XXXL	XXXXL
38	40	42	44	46	48	50	52	54

CAMICIA CLASSICA DONNA

CLASSIC WOMEN'S SHIRT



CAM86
manica lunga



CAM85
manica corta

Camicia donna da abito realizzata in 100% cotone, modello colletto maschile e bottoni in tinta. Disponibile a manica lunga e corta.

Classic women's shirt that is suitable for dresses. Made from 100% cotton. Features a male collar and matching buttons. Both long and short-sleeved shirts are available.

taglie/sizes	XXS	XS	S	M	L	XL	XXL	XXXL	XXXXL
	38	40	42	44	46	48	50	52	54

POLO DS MANICA CORTA CON SPALLINE

DS POLO SHIRT WITH SHOULDER STRAPS



T/S47

nera



T/S64

azzurra

T/S45

blu

T/S67

grigia

Polo realizzata in 100% poliestere (peso 150 grammi) con spalline; il tessuto altamente tecnico con cui è realizzata presenta elevata velocità di asciugamento, alta resistenza alla formazione di pieghe del tessuto e resistenza totale a cloro ed altre sostanze degradanti.

Polo shirt made from 100% polyester (weight: 150g). Features a shoulder strap. High technical fabric ensures a very fast drying, excellent resistance to creases, and totally repellent to chlorine and other degrading substances.

taglie/sizes

XS	S	M	L	XL	XXL	XXXL	XXXXL
40/42	44/46	48/50	52/54	56/58	60/62	64/66	68/70

POLO DS MANICA LUNGA CON SPALLINE

DS LONG SLEEVE POLO SHIRT



T/S48
nera



T/S66
azzurra

T/S46
blu

T/S68
grigia

Versione a maniche lunghe della polo DS, realizzata in 100% poliestere (peso 150 grammi) con spalline.

Long-sleeved polo shirt made with 100% polyester. Comes with the same features as a DS polo shirt. Features shoulder straps. (Weight: 150g)

taglie/sizes

XS	S	M	L	XL	XXL	XXXL	XXXXL
40/42	44/46	48/50	52/54	56/58	60/62	64/66	68/70

PANTALONE TATTICO DS

DS TACTICAL TROUSERS

pantalone operativo

colori/colours	blu	nero	kaki
multistagione	PAN85DS	PAN41DS	PAN100DS
invernale	PAN82DS	PAN61DS	
estivo	PAN90DS		



Pantalone operativo di nuova generazione realizzato in misto cotone e poliestere, dotato di cintura elastica di regolazione in vita che consente una maggiore fluidità nei movimenti a chi lo indossa; con due tasche laterali rinforzate, due tasche posteriori e due a metà gamba con chiusura a velcro rapida, fondo elastico con laccetto per regolazione. Riga cucita davanti lungo la gamba. Disponibile in varie grammature/composizioni.

New generation operational trousers made from a cotton and polyester blend. Features adjustable straps, elastic waistband to ensure easy and convenient gliding movements, two reinforced side pockets, two back pockets, two mid-leg pockets, Velcro straps for quick fastening, and elastic bottom with straps for a better fit.

taglie/sizes

XS	S	M	L	XL	XXL	XXXL	XXXXL
40/42	44/46	48/50	52/54	56/58	60/62	64/66	68/70

PANTALONE TATTICO US

US TACTICAL TROUSERS

pantalone operativo

colori/colours	blu	nero
multistagione	PAN43	PAN41/IMP
invernale	PAN47/IMP	PAN61/IMP
estivo	PAN90	



Pantalone operativo modello U.S. realizzato in misto cotone e poliestere, dotato di fascia elastica nel girovita per una maggiore vestibilità; con due tasche laterali rinforzate; due tasche posteriori e due a metà gamba con chiusura a velcro rapida, fondo elastico con laccetto per regolazione. Disponibile in varie grammature/composizioni.

Operational trousers in a U.S. design. Made from cotton and polyester. Features an elastic waistband for a better fit, two reinforced side pockets, two back pockets, two mid-leg pockets, Velcro straps for quick fastening, and an elastic bottom with adjustable straps. Trousers in different fabric weights and compositions are available.

taglie/sizes

XS	S	M	L	XL	XXL	XXXL	XXXXL
40/42	44/46	48/50	52/54	56/58	60/62	64/66	68/70

PANTALONCINO TATTICO DS

DS TACTICAL SHORTS

colori/colours

blu

nero

multistagione

PAN89DS

PAN97DS

Versione corta del pantalone operativo DS, realizzato in misto cotone e poliestere (peso 240 grammi), che ne rispetta tutte le caratteristiche permettendo di indossarlo anche in situazioni civili.

Operation shorts made from a polyester and cotton blend (weight: 240gr). Same design and features as DS operational trousers and can be worn in civilian settings.



PANTALONCINO TATTICO US

US TACTICAL SHORTS

colori/colours

blu

nero

multistagione

PAN89

PAN97

Versione corta del pantalone operativo US, realizzato in misto cotone e poliestere (peso 240 grammi), che ne rispetta tutte le caratteristiche permettendo di indossarlo anche in situazioni civili.

Operational shorts made from a polyester and cotton blend (weight 240gr). Same design and features as US operational shorts and can be worn in civilian settings.



taglie/sizes

XS	S	M	L	XL	XXL	XXXL	XXXXL
40/42	44/46	48/50	52/54	56/58	60/62	64/66	68/70



Divise Uniforms

GIACCA DIAGONALE

UNIFORM JACKET

alette dritte

colori/colours

blu

estiva

DIA5

invernale

DIA6



Giacca uomo modello diagonale realizzata in misto lana (estiva 270 gr./invernale 520 gr.); dotata di spalline, quattro tasche applicate con alette dritte, bottoni oro e porta distintivo/badge su petto sinistro. Tasche basse con passante per fondina.

Men's uniform jacket, made from a wool blend (winter jacket weight: 520gr, summer jacket weight 270gr). Features shoulder straps, four straight flap pockets, gold buttons, plate/badge holder on the left pectoral, and lower pockets with a gun holster loop.

taglie/sizes

40 | 42 | 44 | 46 | 48 | 50 | 52 | 54 | 56 | 58 | 60 | 62 | 64 | 66 | 68 | 70

GIACCA DIAGONALE

UNIFORM JACKET

alette a 3 punte

colori/colours	blu	nero
estiva	DIA1	DIA10
invernale	DIA2	DIA9
estiva donna	DIA3	
invernale donna	DIA4	



Giacca diagonale realizzata in misto lana (estiva 270 gr./invernale 520gr.); dotata di spalline, quattro tasche applicate con alette a tre punte, bottoni oro e porta distintivo/badge su petto sinistro. Tasche basse con passante per fondina.

Altre grammature disponibili su ordinazione.

Uniform jacket, made from a wool blend (winter jacket weight: 520gr, summer jacket weight 270gr). Features shoulder straps, four pockets with three-pointed flaps, gold buttons, plate/badge holder on the left pectoral, and lower pockets with a gun holster loop. Jacket available in different fabric weights upon request.

taglie/sizes

40 | 42 | 44 | 46 | 48 | 50 | 52 | 54 | 56 | 58 | 60 | 62 | 64 | 66 | 68 | 70

GIACCA CLASSICA LANA UOMO

MEN'S CLASSIC WOOL JACKET

colori/colours	blu	nero	grigio	grigio scuro
estiva	POR02	POR26	POR01	POR01/A
invernale	POR15			



Giacca uomo modello classico 3 bottoni realizzata in misto lana (estiva 270 gr./invernale 480 gr.); con una tasca su petto sinistro e due tasche con pattina, bottoni in tinta. Altre grammature disponibili su ordinazione.

Men's jacket, made from a wool blend (winter jacket weight: 480gr, summer jacket weight 270gr). Features a classic three-button design, a pocket on the left pectoral, two flap pockets, and matching buttons. Jacket available in different fabric weights.

taglie/sizes

40 | 42 | 44 | 46 | 48 | 50 | 52 | 54 | 56 | 58 | 60 | 62 | 64 | 66 | 68 | 70

GIACCA CLASSICA LANA DONNA

WOMEN'S CLASSIC WOOL JACKET

colori/colours	blu	nero	grigio
estiva	POR04	POR20	POR03
invernale	POR17		



Giacca donna modello classico 3 bottoni realizzata in misto lana (estiva 270 gr./invernale 480 gr.); con una tasca su petto sinistro e due tasche basse, bottoni in tinta. Altre grammature disponibili su ordinazione.

Women's jacket, made from a wool blend (winter jacket weight 480gr, summer jacket weight 270gr). Features a classic three-button design, a pocket on the left pectoral, two lower pockets, and matching buttons. Jacket available in different fabric weights.

taglie/sizes	38	40	42	44	46	48	50	52	54	56	58	60	62	64	66	68	70
--------------	----	----	----	----	----	----	----	----	----	----	----	----	----	----	----	----	----

PANTALONE CLASSICO LANA UOMO

MEN'S CLASSIC WOOL TROUSERS

colori/colours	blu	nero	grigio	grigio scuro
estivo	PAN3	PAN66	POR11	POR28
invernale	PAN4	PAN67	POR06	POR30



Pantalone classico uomo realizzato in misto lana (estivo 270 gr./invernale 480 gr.); con due pence, tasche laterali alla francese e due tasche a filetto posteriori, passanti per cintura, bottoni in tinta.

Disponibile in varie grammature/composizioni su ordinazione.

Men's classic trousers, made from a wool blend (winter trouser weight: 480gr, summer trouser weight 270gr). Features two pleats, French-design side pockets, two back welt pockets, belt loops, and matching buttons. Jacket available in different fabric weights.

taglie/sizes

40 | 42 | 44 | 46 | 48 | 50 | 52 | 54 | 56 | 58 | 60 | 62 | 64 | 66 | 68 | 70

PANTALONE CLASSICO LANA DONNA

WOMEN'S CLASSIC WOOL TROUSERS

colori/colours	blu	nero	grigio	grigio scuro
estivo	POR18/A	POR21	POR07/A	POR29
invernale	POR19/A	POR23	POR08/A	POR31

Pantalone classico donna realizzato in misto lana (estivo 270 gr./invernale 480 gr.); senza pence e senza tasche, passanti per cintura, bottoni in tinta. Disponibile in varie grammature/composizioni su ordinazione.

Women's classic trousers, made from a wool blend (winter trouser weight: 480gr, summer trouser weight 270gr). Comes without pleats and pockets. Features belt loops and matching buttons. Trousers in different fabric weights and compositions are available on demand.



GONNA CLASSICA LANA

WOMEN'S CLASSIC WOOL SKIRT

colori/colours	blu	nero	grigio
estiva	POR12	POR24	POR09
invernale	POR13	POR25	POR10

Gonna modello tubino realizzata in misto lana (estiva 270 gr./invernale 480 gr.), con spacco posteriore e passanti per cintura, bottoni in tinta. Disponibile in varie grammature/composizioni su ordinazione.

Pencil skirt made from a wool blend (winter skirt weight 480gr, summer skirt weight 270gr). Features a black slit, belt loops, and matching buttons. Skirts in different fabric weights and compositions are available on demand.



taglie/sizes	38	40	42	44	46	48	50	52	54	56	58	60	62	64	66	68	70
--------------	----	----	----	----	----	----	----	----	----	----	----	----	----	----	----	----	----

GIACCA CLASSICA POLIVISCOSA UOMO

MEN'S CLASSIC VISCOSE POLYESTER JACKET



POR57

blu



POR75

nero

Giacca uomo modello classico 3 bottoni tutta stagione realizzata in poliestere/viscosa/elastan per una migliore vestibilità e comodità; con una tasca su petto sinistro e due tasche con pattina, bottoni in tinta.

Men's jacket, made from viscose/polyester/elastin. Features a classic three-button design for better fit and comfort, a pocket on the left pectoral, two flap pockets, and matching buttons.

taglie/sizes

40 | 42 | 44 | 46 | 48 | 50 | 52 | 54 | 56 | 58 | 60 | 62 | 64 | 66 | 68 | 70

GIACCA CLASSICA POLIVISCOSA DONNA

WOMEN'S CLASSIC VISCOSE POLYESTER JACKET



POR59

blu



POR73

nero

Giacca donna modello classico 3 bottoni tutta stagione realizzata in poliestere/viscosa/elastan per una migliore vestibilità e comodità; con una tasca su petto sinistro e due tasche, bottoni in tinta.

Women's jacket, made from viscose/polyester/elastin for better fit and comfort. Features pocket on the left pectoral, two additional pockets, and matching buttons.

taglie/sizes

38

40

42

44

46

48

50

52

54

56

58

60

62

64

66

68

70

PANTALONE CLASSICO POLIVISCOSA UOMO

MEN'S CLASSIC VISCOSE POLYESTER TROUSERS



POR62
grigio



POR76
nero



POR61
blu

Pantalone classico uomo tutta stagione realizzato in poliestere/viscosa/elastan per una migliore vestibilità e comodità; con due pinces, tasche laterali alla francese e due tasche a filetto posteriori, passanti per cintura, bottoni in tinta.

Men's classic trousers, made from viscose/polyester/elastin for better fit and comfort. Features two pleats, French-designed side pockets, black welt pockets, belt loops, and matching buttons.

taglie/sizes

40 | 42 | 44 | 46 | 48 | 50 | 52 | 54 | 56 | 58 | 60 | 62 | 64 | 66 | 68 | 70

PANTALONE CLASSICO POLIVISCOSA DONNA

WOMEN'S CLASSIC VISCOSE POLYESTER TROUSERS

Pantalone classico donna tutta stagione realizzato in poliestere/viscosa/elastan per una migliore vestibilità e comodità; senza pinces e senza tasche, passanti per cintura, bottoni in tinta.

Women's classic trousers, made from viscose/polyester/elastin for better fit and comfort. Comes without pleats and pockets. Features belt loops and matching buttons.



POR74
nero



POR66
grigio



POR65
blu

GONNA POLIVISCOSA

VISCOSE POLYESTER SKIRT

Gonna modello tubino tutta stagione realizzata in poliestere/viscosa/elastan per una migliore vestibilità e comodità; con spacco posteriore e passanti per cintura, bottoni in tinta.

Pencil skirt made from viscose/polyester/elastin for better fit and comfort. Features black slit, belt loops, and matching buttons.



POR69
blu

POR77
grigio

taglie/sizes

38 | 40 | 42 | 44 | 46 | 48 | 50 | 52 | 54 | 56 | 58 | 60 | 62 | 64 | 66 | 68 | 70

CRAVATTE

in poliesterre

POLYESTER TIE



CRA 1

blu



CRA 2

nero



CRA 5

rosso



CRA 6

bordeaux



CRA 19

marrone

CRAVATTE REGIMENTAL

in misto seta

REGIMENTAL TIE



CRA 8

blu
righe rosse



CRA 36

blu
righe gialle



CRA 29

blu
righe arancio

FERMA CRAVATTE

TIE CLIPS



CRA 10

oro



CRA 22

nikelato



CRA 21

oro
con molla

FOULARD



ASCOTT



CRA 15

blu



CRA 16

royal



CRA 17

nero



CRA 20

rosso



CRA 30

blu
righe arancio



CRA 30/G

blu
righe giallo



CRA 31

nero
righe arancio

Su richiesta possibilità di realizzare cravatte, ascott e foulard personalizzati



Placche Emblems

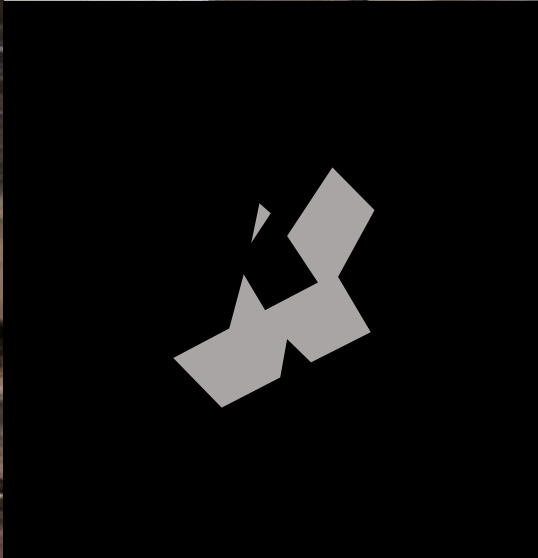

PLACCHE

EMBLEMS

SAGOMA 1

PLACCA DA BERRETTO CONTROSTAMPATA DUE CARTIGLI

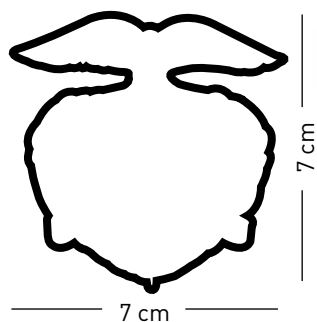

SAGOMA 2

PLACCA DA PETTO CONTROSTAMPATA TRE CARTIGLI

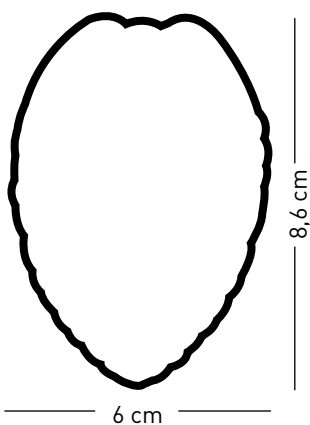

PLACCHE

EMBLEMS

SAGOMA 3

PLACCA DA PETTO A RAGGIERA DUE CARTIGLI

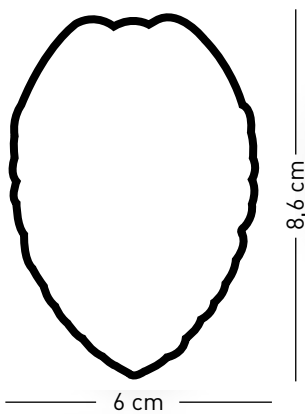

SAGOMA 4

PLACCA DA PETTO MODELLO GIUSTIZIA DUE CARTIGLI

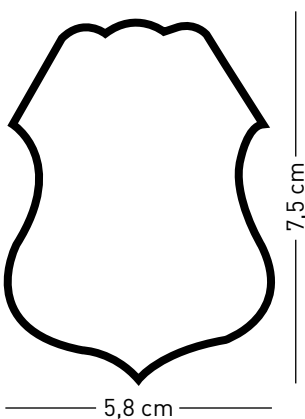

PLACCHE

EMBLEMS

SAGOMA 5

PLACCA DA PETTO MODELLO ARALDICO

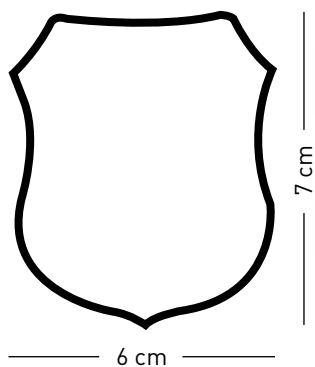

SAGOMA 6

PLACCA DA PETTO MODELLO TONDO RAGGIERA

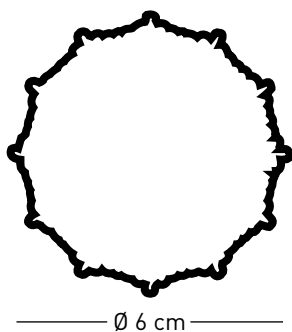

PLACCHE

EMBLEMS

SAGOMA 7

PLACCA DA PETTO MODELLO LOS ANGELS
CONTROSTAMPATA

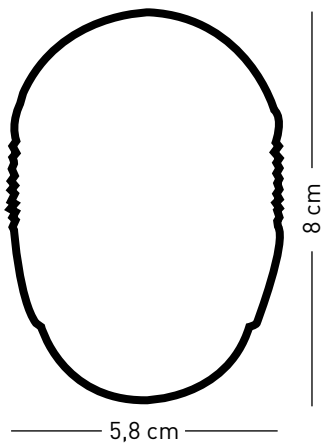

SAGOMA 8

PLACCA DA PETTO MODELLO SCUDO A PUNTA
CONTROSTAMPATA

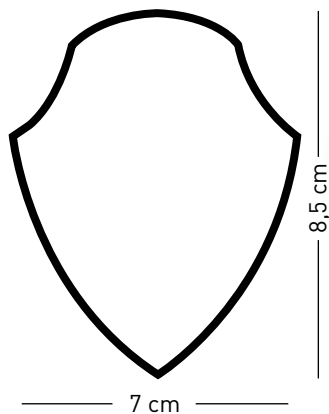



ALAMARI per camicia



ACV 8
blu



ACV 22
rosso



ACV 40
nero

Alamari in metallo colore oro con bordo blu/rosso/nero da camicia con morsetto coppia.

ALAMARI per giacca



ACV 7
blu



ACV 25
rosso



ACV 41
nero

Alamari in metallo colore oro con bordo blu/rosso/nero da giacca con morsetto coppia.

MOSTRINE personalizzazioni

SAGOMA 01

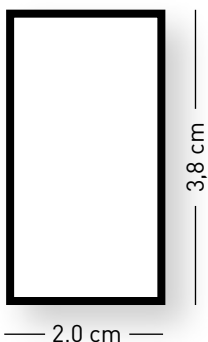

Mostrine in metallo rettangolari misura 3,8x2,0 cm realizzate con logo personalizzato coppia.

SAGOMA 02

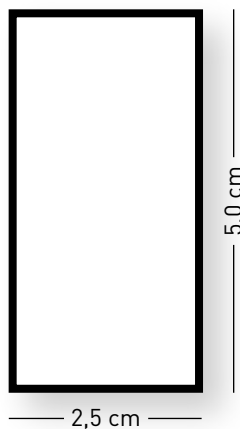

Mostrine in metallo rettangolari misura 5,0x2,5 cm realizzate con logo personalizzato coppia.

SAGOMA 03

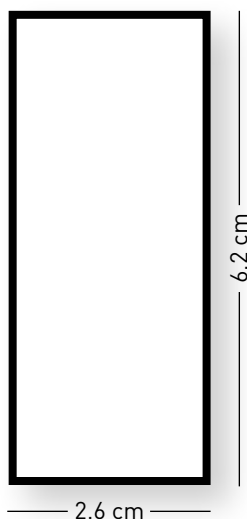

Mostrine in metallo rettangolari misura 6,2x2,6 cm realizzate con logo personalizzato coppia.

MOSTRINE personalizzazioni

SAGOMA 04

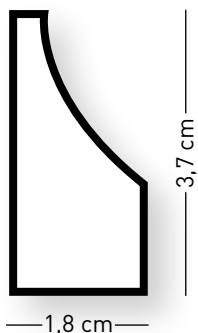

Mostrine in metallo rettangolari misura 3,7x1,8 cm realizzate con logo personalizzato coppia.

MOSTRINE DA COLLO personalizzazioni

M.F.

SIS

V.C.V.

S.D.S.

CIVIS

FIDELITAS

N.S.G.

V.V.2

TARGHETTE DA PETTO personalizzazioni



STEMMI personalizzazioni PATCH

SAGOMA 01

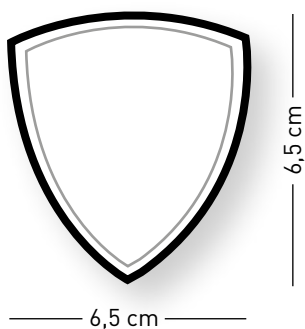

SAGOMA 02

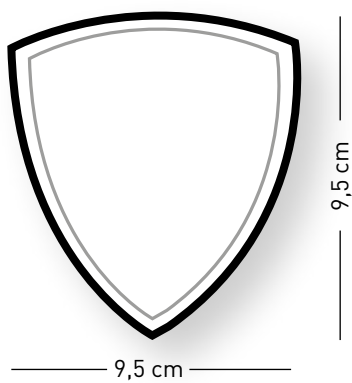

STEMMI personalizzazioni PATCH

SAGOMA 03

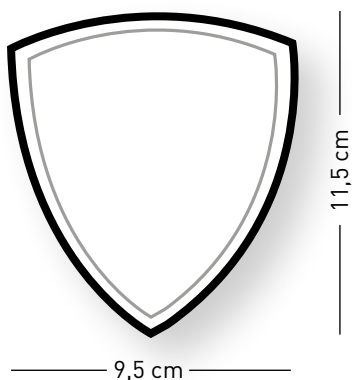

SAGOMA 04

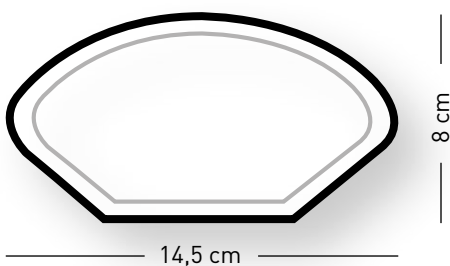

STEMMI

personalizzazioni

PATCH

SAGOMA 05

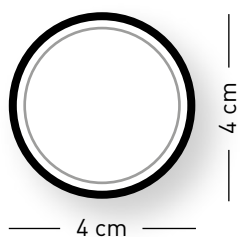

SAGOMA 06

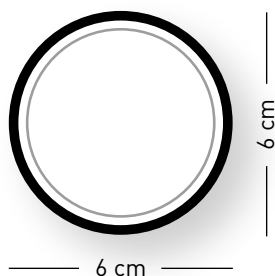

SAGOMA 07

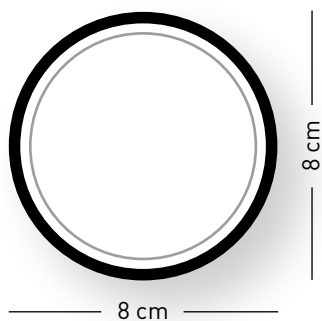

SAGOMA 08

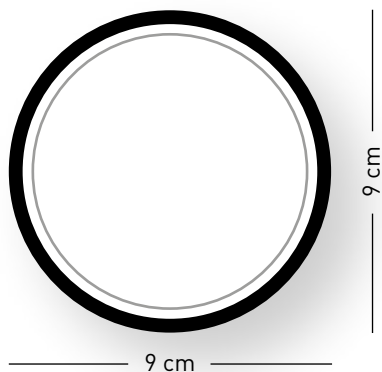

STEMMI personalizzazioni PATCH

SAGOMA 09

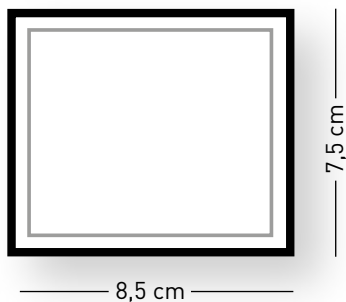

SAGOMA 10

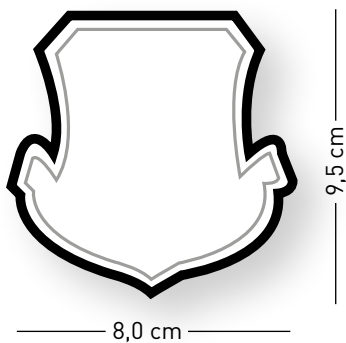

STEMMI

personalizzazioni
PATCH

SAGOMA 11

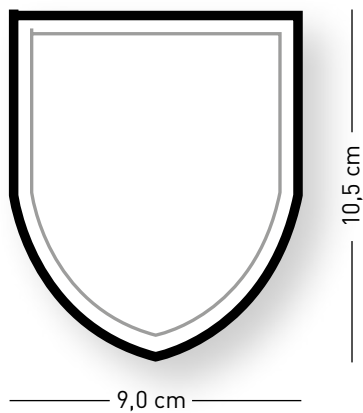

SAGOMA 12

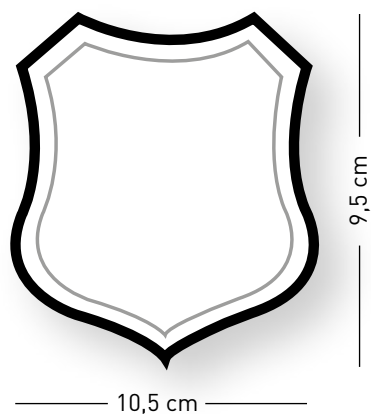

STEMMI

personalizzazioni
PATCH

SAGOMA 13

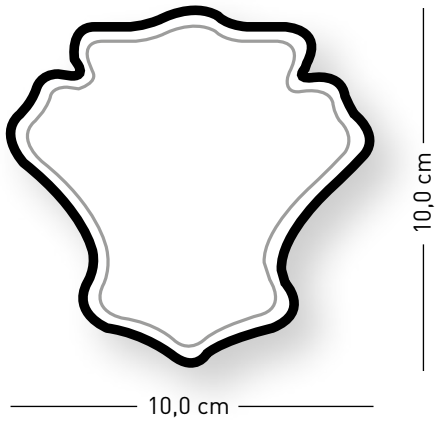

SAGOMA 14

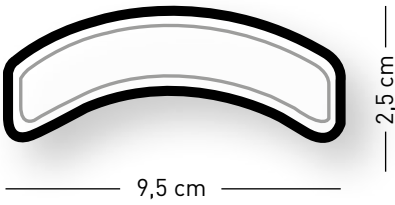

SAGOMA 15

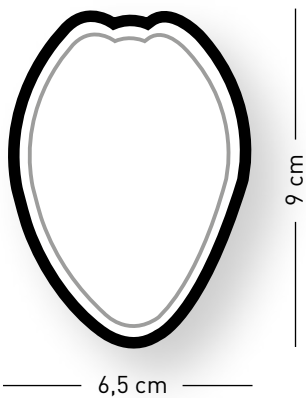

STEMMI

personalizzazioni

PATCH

SAGOMA 16

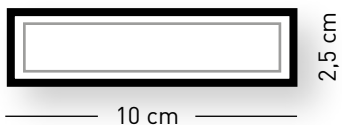

SAGOMA 17

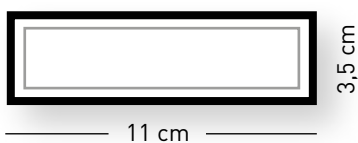

SAGOMA 18



SAGOMA 19

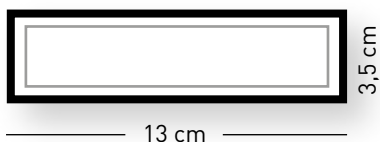

SAGOMA 20

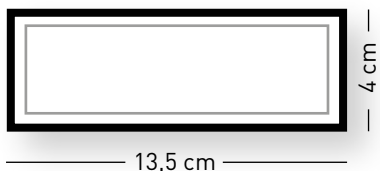





GPG

VGB

GPG

EG

PPA

G.P.G.

NC

G.S.I.

VIGILANZA

T.C.T.
G.G.

VIGILANZA
NATIONAL SECURITY
CAGLIARI

G G

BICURITALIA

SECURITY

G.P.G.

G

TUBOLARI

tela/plastica
SHOULDER STRAPS

Su richiesta possibilità di realizzare tubolari personalizzati in tela/plastica o ricamati



TUB 1
blu
coppia



TUB 2
nero
coppia

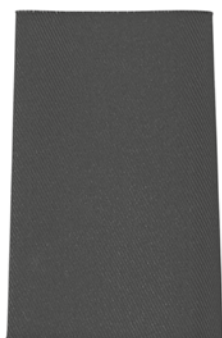

TUB 3
grigio scuro
coppia



TUB 12
bordeaux
coppia



TUB 5
blu bordo
azzurro
coppia



TUB 6
blu bordo
buckingham
coppia



TUB 7
blu bordo
rosso
coppia



TUB 8
blu bordo
bordeaux
coppia



TUB 4
blu bordo
giallo
coppia



TUB 17
blu bordo
blu
coppia



TUB 18
blu bordo
verde
coppia



TUB 11
nero bordo
giallo
coppia



TUB 13
nero bordo
grigio
coppia



TUB 16
nero bordo
rosso
coppia

GRADI in metallo

METAL RANKS



GRA 44

Aquila nikel
coppia



GRA 43

Foglia nikel
coppia



GRA 42

Barretta doppia
nikel coppia



GRA 41

Barretta singola
nikel coppia



GRA 40

Baffo triplo
nikel coppia



GRA 39

Baffo singolo
nikel coppia



GRA 1

Aquila oro
coppia



GRA 2

Foglia oro
coppia



GRA 4

Barretta doppia
oro coppia



GRA 14

Barretta singola
oro coppia



GRA 8

Baffo triplo
oro coppia



GRA 9

Baffo doppio
oro coppia



GRA 11

Baffo singolo
oro coppia



GRA 13

Baffo semplice
oro coppia



GRA 31

Aquila nikel
coppia



GRA 3

Foglia nikel
coppia



GRA 5

Barretta doppia
nikel coppia



GRA 7

Barretta singola
nikel coppia



GRA 30

Baffo triplo
nikel coppia



GRA 10

Baffo doppio
nikel coppia



GRA 12

Baffo singolo
nikel coppia



GRA 29

Baffo semplice
nikel coppia



GRA 45

Foglia rossa
coppia



GRA 32

Barretta doppia
rossa coppia



GRA 6

Barretta singola
rossa coppia



GRA 18

Baffo triplo
rosso coppia



GRA 28

Baffo doppio
rosso coppia



GRA 19

Baffo singolo
rosso coppia

SPILLE
in metallo
METAL QUALIFICATIONS



ACV 13

 CAPO SERVIZI SQS 1	 CAPO SERVIZIO SQS 1/A	 ISTRUTTORE TIRO SQS 2	 RESPONSABILE SEZIONE SQS 3
 CENTRALE OPERATIVA SQS 4	 ISTRUTTORE ZONE SQS 5	 SCORTA VALORI SQS 6	 SERVIZI AEROPORTUALI SQS 7
 UNITÀ CINOFILA SQS 8	 ISTRUTTORE GPG SQS 9	 UFFICIO SERVIZI SQS 10	 RADIO MOBILE SQS 11
 VIGILANZA FISSA SQS 12	 VICE CAPO SERVIZI SQS 13	 VICE CAPO SERVIZIO SQS 13/A	 ANTIRAPINA SQS 14
 PRONTO INTERVENTO SQS 15	 ISTRUTTORE SQS 16	 ISPETTORE SQS 17	 TRASPORTO VALORI SQS 18
 SALA OPERATIVA SQS 19	 AGENTE I CL SQS 20	 RESPONSABILE OPERATIVO SQS 21	 RESPONSABILE CENTRALE SQS 22
 CAPO POSTO SQS 23	 RESPONSABILE LOGISTICO OPERATIVO SQS 24	 1ª CLASSE SQS 25	 VIGILE 1ª CL SQS 26
	 REFERENTE DI SERVIZIO SQS 27	 SQUADRA EMERGENZA SQS 28	

CAMICI-TUTE-COMPLETI

OVERALL

Camice tipo medico per sala operativa con due tasche e un taschino e martingala.



CAE 15
Camice royal



CAE 14
Camice blu



CAE 1
Camice bianco

CAE 2
Camice donna
royal

CAE 16
Camice donna
blu

CAE 1/D
Camice donna
bianco



CAE 18
Giacca



CAE 10
Tuta



CAE 5/A
Casacca
manica corta
+ pantalone

CAE 6
Casacca
manica lunga
+ pantalone



CAE 17
Pantalone

Giacca e pantalone per sala conta, colore blu scuro, bielastico, senza tasche.

Tuta sala conta realizzata in misto cotone colore royal con cerniera frontale elastico ai polsi e alle caviglie, senza tasche.

Casacca e pantalone per sala conta colore royal senza tasche con solo un porta biro.

taglie/sizes

XS	S	M	L	XL	XXL	XXXL	XXXXL
40/42	44/46	48/50	52/54	56/58	60/62	64/66	68/70



Sicurezza Security

GILET e PETTORINE



PET4

**Pettorina
blu**

Pettorina realizzata in misto cotone neutra.



PET6

**Pettorina
con 3M**

Pettorina realizzata in misto cotone colore blu con due bande 3M anteriori e posteriori.



4AV04

**Pettorina
gialla**

Corpetto alta visibilità colore giallo con due bande 3M anteriori e posteriori, elastici laterali.



PET7

**Fascia
braccio**

Fascia da braccio tessuto HV colore giallo con stampa scritta vigilanza security con possibilità di applicazione stemma.



GHV28

**Pettorina
con 3M**

Gilet giallo alta visibilità con bande 3M classe 2 (certificato DPI).



4AV00

**Copri
berretto**

Copri berretto giallo alta visibilità 2 bande 3M e finestra trasparente.



PL133

**Manicotti
gialli**

Manicotti gialli alta visibilità 2 bande 3M a norma, con elastici.



4AV03

**Ghette
gialle**

Ghette gialle alta visibilità 2 bande 3M, con cerniera.

ACCESSORI

ACCESSORIES



R136

Elmetto di sicurezza

Elmetto privo di aperture, con predisposizione tramite aggancio per sistemi di visiere cuffie e lampade. Fornisce protezione a temperature estremamente basse (-30° C). resistenza a metallo fuso (spruzzi). Sospensione interna in tessuto a 6 cardini, ampia fascia antisudore Certificato EN 50365.



R440

Elmetto di sicurezza

Elmetto dotato di 3 aperture di ventilazioni richiudibili. Predisposizione aggancio per sistemi di visiere cuffie e lampade. Visiera ridotta per una maggiore visibilità verso l'alto. Fornisce una protezione a temperature estremamente basse (-30° C), resistenza a metallo fuso (spruzzi). Bardatura con regolazione a cremagliera, sospensione interna in tessuto, ampia fascia antisudore.



H060/02

H060/08

H060/07

Elmetto di sicurezza

Elmetto 100% polietilene, peso 350 g compreso di bardature a 6 cardini con regolazione nucale, predisposto per attacco cuffia, isolamento elettrico 440 V.



R200

Inserti auricolari

Inserti auricolari monouso realizzati in polimero di espanso, offrono ottima protezione e comodità per tutta la giornata lavorativa.



R222

Occhiali di protezione

Modello avvolgente, ampia veduta, protezioni laterali e sopraccigliari, lenti chiare resistenti agli urti di bassa energia (F), si può indossare sopra gli occhiali da vista. Montatura in policarbonato.



SC08

Cuffia optime

Cuffia di protezione auricolare con bardatura temporale, per ambienti molto rumorosi, massima attenuazione anche alle basse frequenze, ampi cuscinetti imbottiti adatti ad usi prolungati.



ACV5

Paletta segnalazione

Paletta di segnalazione in plastica colore rosso/rosso.



ACV16

Fischetto

ACV3

Catenella per fischietto con clip

SCANNER e SPECCHI

SECURITY METAL DETECTOR AND UNDER-VEHICLE ISPECTION

Metal detector palmare, per effettuare rapidi controlli su persone e bagagli.

Dotato di sensibilità regolabile e doppia tipologia di allarme, è essenziale per il mantenimento di un alto livello di sicurezza in tutti i luoghi sensibili e potenzialmente a rischio.

Con sensore di rilevazione a 360°, regolazione della sensibilità e pulsante per l'eliminazione di interferenze, allarme audio e a vibrazione, controllo del volume, indicatore del livello di segnale e della batteria, dotato di jack per il collegamento di cuffie o caricatore.

SecurSCAN MY-18 is a handheld metal detector, to perform rapid checks on people and luggage. Provided with adjustable sensitivity and double type of alarm, it is essential for maintaining a high level of security in all sensitive and potentially at-risk places. 360° detection sensor, sensitivity setting, button for interference elimination, acoustic or vibrating alarm, signal and volume level control, headphone/charger connection jack.



MY 18

Metal detector



ACV44

Specchio di controllo

Specchio d'ispezione veicoli con asta telescopica a due elementi in alluminio anodizzato, lunghezza minima 110 cm, massima 210 cm. optional specchio diametro 30 cm, illuminazione torcia a luce Xenon 2,4 V.

Telescopic rod with two elements in anodized aluminum, minimum length 110 cm, maximum 210 cm. optional mirror diameter 30 cm, 2.4 V Xenon light torch illumination.



EFIS04

Specchio di controllo

Specchio d'ispezione veicoli montato su telaio in acciaio ad alta resistenza su ruote e resistente agli acidi e agli urti.

Dimensioni standard dello specchio 20x30 cm. Asta telescopica a due elementi, Illuminazione specchio antiabbagliamento tramite dieci led.

Mirror mounted on a high-resistance steel frame on wheels and resistant to acids and impacts. Standard dimensions of the mirror 20x30 cm. Telescopic rod with two elements, Anti-glare mirror illumination through ten leds.

SCANNER

SECURITY METAL DETECTOR



1165800

Metal detector Superwand

Metal Detector palmare autocalibrante, con ottima sensibilità e con superficie di scansione a 360°.
Dotato di indicatori LED e allarme in modalità acustica e vibrazione. Rileva qualsiasi materiale ferroso. Struttura ABS e kit di batterie ricaricabili.

Handheld metal detector with 360° detection range. There is no periodic calibration and is able to withstand high volumes of traffic. It is provided with 2 different alarm modes and it is made of high-strength ABS.



1165190

Metal detector garrett palmare superscanner V nuovo modello

Metal Detector palmare autocalibrante, con sensibilità regolabile ed ampia superficie di scansione, dotato di indicatori LED e allarme in modalità acustica, visiva e con vibrazione. Rileva qualsiasi materiale ferroso. Struttura ABS anti urto.

Handheld metal detector with adjustable sensitivity and large scanning surface, equipped with LED indicators and alarm in acoustic, visual and vibration mode. Detects any ferrous material. ABS structure anti impact.

1165900

Metal detector garrett palmare THD

Il più compatto e maneggevole Metal Detector con ottima sensibilità e con superficie di scansione a 360°; allarme con vibrazione.
Dotato di torcia LED integrata; impermeabile e resistente agli urti. Fondina da cintura inclusa.

Handheld metal detector with 360° detection range. There is no periodic calibration and is it provided with 2 different alarm modes, made of high-strength ABS, waterproof and impact-resistant. Integrated LED flashlight and belt holster included.

MAGLITE SET SYSTEM LED

ricaricabile

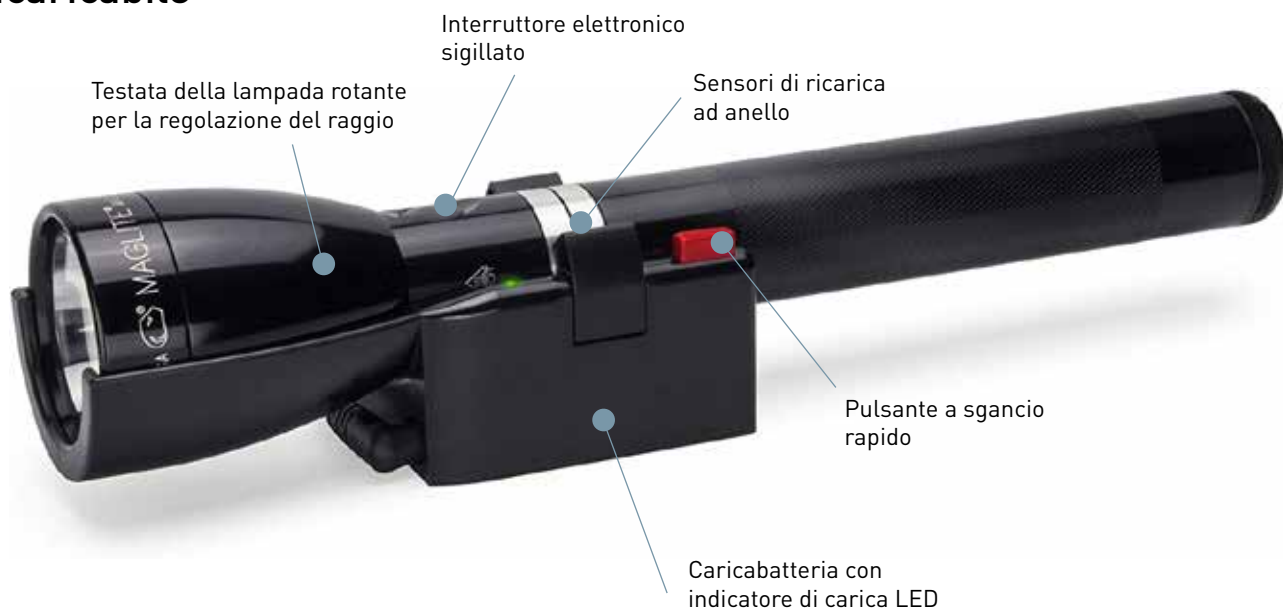

LED17

Torcia set system

Torcia ricaricabile di medie dimensioni (circa 27 cm) con lampadina LED, ricaricabile tramite corrente domestica o su veicoli, la base di ricarica può essere montata anche in posizione verticale o capovolta, il nuovo pulsante a sgancio consente un recupero rapido e senza sforzo.

Attraverso la testa della torcia è possibile la regolazione del raggio luminoso in 5 funzioni disponibili: tre impostazioni di potenza (alta-bassa-eco), Strobe e On/Off.



SET	1 GENERALE	2 ESTERNO	3 FORZE ORDINE	4 TATTICO
1 CLICK	Piena potenza	Piena potenza	Momentaneo	Momentaneo
2 CLICKS	Risparmio energetico	Risparmio energetico	Piena potenza	Piena potenza
3 CLICKS	Eco	Stroboscopio	Eco	Stroboscopio

	FL 1 STANDARD	ALTO	BASSO	ECO
458m	1082 LUMENS	2.5h	Resistente all'acqua	Resistente alla caduta
Distanza raggio luce	Lumens	Tempo di ricarica	Tempo di utilizzo alto	Tempo di utilizzo basso
			3hr 15 min	18hr
				79hr
			Tempo di utilizzo eco	

ACCESSORI PER TORCIA



LED40
Caricabatterie per maglite spina universale



LED41
Caricabatterie per maglite da automobile



LED42
Batteria interna ricaricabile



MAG60
Attacco da parete

TORCE FAVOUR

ricaricabili



1030
LUMEN



200
GRAMMI

T1417

Torcia a Led bianco con potenza fino a 1030 lumen, impermeabile. Pulsante elettronico con 4 modalità di utilizzo: alta, media, bassa e lampeggiante. Ricaricabile tramite micro USB in 4 ore (con voltaggio 1000 watt) con indicatore a led rosso/verde.

White Led flashlight with power up to 1030 lumens, waterproof. Electronic button with 4 modes of use: high, medium, low and flashing. Direct plug to recharge by micro USB, 4 hours charging time, with red/green led indicator.

T1417BAT Pacco batteria ricaricabile



1000
LUMEN

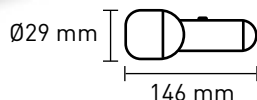

166
GRAMMI

T2117

Torcia a Led bianco con potenza fino a 1000 lumen, fascio regolabile sulla ghiera e pulsante elettronico con 5 modalità di utilizzo: alta, media, bassa, turbo e lampeggiante. Ricaricabile tramite micro USB con indicatore a led.

White LED flashlight with power up to 1000 lumens, adjustable beam on the ring and electronic button with 5 modes of use: high, medium, low, turbo and flashing. Direct plug to recharge by micro USB, led indicator.



1000
LUMEN

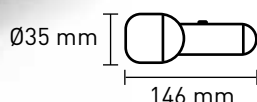

195
GRAMMI

T2717

Torcia a Led bianco, rosso o blu con potenza fino a 1000 lumen, fascio regolabile e 8 modalità di utilizzo. Resistente alla polvere e impermeabile. Ricaricabile tramite micro USB con indicatore a led.

White, red or blue LED flashlight with power up to 1000 lumens, adjustable beam and 8 modes of use. dustproof and waterproof. Direct plug to recharge by micro USB, led indicator.



FARI BRANDEGGIANTI

SEARCHING LIGHTS

ACV66

Fisso



ACV65

Magnetico

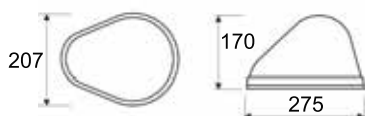

Faro di ricerca alogeno a brandeggio elettrico, provvisto di:

- fonte luminosa composta da:
lampada H1 55W(12V) e parabola riflettente Ø 115 mm
- movimento verticale 105-110°
- movimento orizzontale 360° no stop
- telecomando di movimentazione

Halogen electric searching light, provided with:

- luminous source composed of:
halogen bulb H1 55W(12V)
- reflecting parable Ø 115 mm
- vertical movement 105-110°
- horizontal movement 360° no stop
- remote control

Codice Code	Colore Colour	Voltaggio Voltage	Parabola Parable	Luce Lights	Montaggio Mounting	Peso Weight	Altezza Height	IP
ACV66 (EBL1255.B)	○	12V	Ø115mm	H1 55W	⌋⌋⌋	1420gr	170mm	65
ACV65 (EBL1255.M1)	○	12V	Ø115mm	H1 55W	⌋	1550gr	190mm	65



ACV79

Fisso led

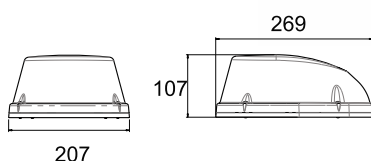

Faro di ricerca LED, con forma ribassata ed aerodinamica, a brandeggio elettrico. Provvisto di:

- dispositivo automatico di antiabbagliamento all'accensione e ritorno in posizione allo spegnimento
- fonte luminosa composta da 6 LED
- movimento verticale 110°
- movimento orizzontale 360° no stop

Versione telecomandata BL6 Omnilux provvista di telecomando di movimentazione.

Low profile LED electric searching light provided with:

- automatic anti-dazzle device and identification of the shaft of light in light up phase
- 6 LEDs
- Vertical movement 110°
- Horizontal movement 360° no stop

Remote controlled version BL6 Omnilux provided with movement remote control.

Codice Code	Colore Colour	Voltaggio Voltage	LED LEDES	Tipo Type	Montaggio Mounting	Peso Weight	Altezza Height	IP	Versione Version
ACV79 (BLE.12)	○	12V	6	LED	⌋⌋⌋	1350gr	107mm	65	TELE

CASSETTE PRIMO SOCCORSO



DM CPS513

Cassetta pronto soccorso auto

MEDIC 1 ALL. 2 BASE (da auto)

Conforme al DM 388 del 15/07/2003 allegato 2 e D.L. 81 del 09/04/08 art.45
Valigetta realizzata in polipropilene antiurto, colore arancio, supporto per attacco a parete, maniglia per trasporto, chiusura con 2 clip rotanti.

Adatta per aziende o unità produttive con meno di tre lavoratori che non rientrano nel gruppo A. L'art.2 punto 5 del DM 388 del 15.7.2003 prevede che il contenuto di cui all'allegato 2 deve essere fornito ai lavoratori che operano in luoghi diversi dalla sede aziendale o unità produttiva.

Dimensioni (L x H x P): 250x190x90 mm - Peso: 1,40 kg



DM CPS517

Cassetta pronto soccorso

MEDIC 2 ALL.1 BASE

Conforme al DM 388 del 15/07/2003 allegato 1 e D.L. 81 del 09/04/08 art.45

Valigetta colore arancio dotata di supporto per attacco a parete, maniglia per trasporto, guarnizione in neoprene e chiusura con due clip rotanti.

Adatto ad aziende con tre o più lavoratori.

Dimensioni (L x P x H): 395x135x270 mm - Peso: 6,20 kg



DM CPS523

Cassetta pronto soccorso

102/M ALL.1 BASE

Conforme al DM 388 del 15/07/2003 allegato 1 e D.L. 81 del 09/04/08 art.45

Armadietto in metallo verniciato con polvere epossidica colore bianco, 3 vani, 2 ripiani interni, serratura con chiave.

Adatto ad aziende con tre o più lavoratori.

Dimensioni (H x L x P): 460x300x140 mm - Peso: 7,50 kg



DM PDM089

Pacco reintegration con sfigmomanometro

Pacco medicazione per cassette pronto soccorso e armadietti con contenuto base all.1



DM PDM090

Pacco reintegration

Pacco medicazione per cassette pronto soccorso e armadietti con contenuto base all.2



DM PDM091

Pacco reintegration senza sfigmomanometro

Pacco medicazione per cassette pronto soccorso e armadietti con contenuto base all.1 Per rispettare il DM 388 è necessario integrare il contenuto con lo sfigmomanometro che in questo pacco non è compreso.

DEFIBRILLATORE

Compatto e leggero è facile da usare grazie alla presenza di comandi vocali e visivi, guida chi lo usa durante tutto il processo di soccorso. Può essere usato anche senza necessità di estrarlo dallo zainetto di contenimento. L'Onda bifasica SCOPE permette al defibrillatore di gestire range di impedenza maggiori rispetto ad altri dispositivi, offrendo un'ottima performance risulta la migliore terapia salvavita con il più basso livello di effetti collaterali per le cellule cardiache. La cartuccia Pad-Pak permette di avere un'unica data di scadenza da controllare dopo l'uso oppure dopo 4 anni dalla data di produzione, si sostituisce la cartuccia con ripristino istantaneo dell'operatività della macchina.



PVS22
Defibrillatore semi automatico



PVS23
Armadietto da esterno per defibrillatore

Dimensioni esterne (L x P x H): 425x215x480 mm
Realizzata in acciaio al carbonio, saldature a tenuta stagna, porta a tenuta d'acqua e polvere e con possibilità di applicazione di lucchetto o sigillo (non forniti). Teca non adatta per località marittima.



PVS24
Teca da interno per defibrillatore

Misure: 425x425x180 mm
Realizzata in lamiera di acciaio al carbonio zincato. Chiusura a sigillo lucchettabile; preforata per attacco a parete e su apposita piantana cod. PVS26.



PVS25
Kit accessori per defibrillatore

Il kit contiene:
1 pocket mask
1 salvietta disinfettante
1 busta da 4 guanti in vinile
1 rasoio per tricotomia
3 buste garza sterile cm 18x40



PVS26
Piantana per teca

Misure (P x L x H): 150x250x1000 mm - base (L x P): 300x150 mm
Piantana dotata di fori per fissaggio a pavimento e sistema ad incastro. Realizzata in lamiera di acciaio al carbonio zincato.



PVS27
Cartello bifacciale dae-aed per defibrillatore

Dimensioni per lato: 29x36 cm
Cartello in fogli di alluminio bifacciale. Preverniciato di bianco con serigrafia in colore verde. Preforato per attacco a parete. Conforme alla normativa UNI EN ISO 7010:2012



PVS29
Piastre per defibrillatore di ricambio



www.VEGAHOLSTER.COM



CINTURE e CINTURONI

BELTS



CIN 1

Nero

Cintura con fibbia in metallo nikelata a cassetta. Altezza cm 4 e lunghezza mt 1,30.

Canvas belt adjustable iron buckle.

CIN 2

Blu



CIN5

Sottocintura in nylon con parte esterna in velcro uncino, chiusura regolabile, H 4cm.

Nylon under belt. Front side in velcro male. Adjustable velcro clousure.



CIN7

Cinturone realizzato in cordura Du-Pont con fibbia in abs chiusura Quick lock. Colore nero.

Nylon belt, safety buckle Quick lock open system.

TAGLIE DISPONIBILI/SIZE AVAILABLE

0 | 1 | 2 | 3



1V61

Cintura in pelle h.4 cm con fibbia in metallo ad un ardiglione.

4 cm high leather duty belt.

COLORI DISPONIBILI/COLOUR AVAILABLE

Nero, bianco/Black, white.

TAGLIE DISPONIBILI

S | M | L | XL



CIN8

Cinturone in pelle tipo PS con fibbia in metallo, doppio sistema di aggancio pomello più 2 ganci sottofibbia, h 5cm.

Leather duty belt, two hooks clousure: knob plus two sub-buckle hooks.

COLORI DISPONIBILI/COLOUR AVAILABLE

Nero, bianco/Black, white.

TAGLIE DISPONIBILI

XS | S | M | L | XL | XXL

ACC24

Bandoliera per cinturone accessorio aggiuntivo a cod. CIN8.

Leather bandoleer



FONDINE HOLSTERS



T2
Fondina Thumb

Fondina in cordura da cintura con sgancio rapido regolabile con sicura. Sistema passante con Techno asole. Due usi: inclinata sul fianco destro o cross-draw.

Nylon belt holster adjustable quick release. Polymer belt loop. Two uses: inclined on the right side and cross draw.

COLORI DISPONIBILI/COLOUR AVAILABLE

■ Nero/Black

Disponibile per		
FON 26	Beretta 92/98 auto	T 250
FON 25	Beretta 84 S/auto	T 251
FON 27	Revolver	T 253



TK2
Fondina supporto morbido

Fondina in cordura da fianco, sistema di sgancio rapido "Vega Stop Snap". Regolabile ed amovibile. Supporto in cordura morbida, posizione verticale più inclinazioni.

Nylon belt holster quick adjustable release "Vega Stop Snap". Polymer support, vertical position plus inclinations.

COLORI DISPONIBILI

■ Nero/Black

Disponibile per		
FON 42	Beretta 92/98 auto	TK 250
FON 43	Beretta 84 S/auto	TK 254
FON 44	Glock 19/23/25/28/30	TK 252
FON 45	Glock 20/21 USP Walther 99	TK 255



P2
Fondina tactical

Fondina in cordura da fianco, sistema di sgancio rapido "Vega Stop Snap". Regolabile ed amovibile. Supporto in polimero distante dal corpo posizione verticale più inclinazioni.

Belt holster with adjustable safety lace with "Vega Stop Snap" mechanism. Polymer belt loop.

COLORI DISPONIBILI

■ Nero/Black

Disponibile per		
FON 1	Beretta 92/98 auto	P 250
FON 2	Beretta 84 S/auto	P 254
FON 3	Revolver	P 251
FON 28	Glock 19/23/25/29/30	P 252
FON 29	Glock 20/21 USP Walther 99	P 255
FON 32	Glock 17/22	P 253

FONDINE HOLSTERS



mds con grado di sicurezza 2°

VKD8

Fondina polimero



PB1

Fondina polizia US



Fondina in pelle chiusa con pattina da ordinanza carabinieri, doppio moschettone e passante.

Leather belt flap holster. Amovable double spring clip belt support.

**COLORI DISPONIBILI
COLOUR AVAILABLE**

■ Nero/Black

Disponibile per

FON 21 | Beretta 92/98 auto

S 100

Fondina CC

Fondina in speciale polimero stampato in termoforatura; foderata internamente per una maggiore protezione dell'arma e silenziosità. Sistema di sicurezza superiore con facilità di estrazione e vite di ritenzione sulla canna.

Vegatek thermo-molding professional holster. Safety grade II. Internal soft lining for better protection of the firearms and less noise emission. Easy action safety system on the top. Retention screw on the barrel.

COLORI DISPONIBILI/COLOUR AVAILABLE

■ Nero/Black

Disponibile per

VKD800	Beretta 92/96/97/ Brigadier 92/98 Compact Taurus
VKD801	Beretta 81/82/84/85/87
VKD802	H&K USB Standard
VKD804	Glock 17/22/31/37
VKD807	Sig Sauer PRO 2022
VKD808	PX 4 Storm
VKD809	Glock 19/23/25/32/38
VKD812	Walther P99
VKD846	H&K USB Compact/P2000
VKD847	Tanfoglio Force Standard/Police/PRO
VKD848	Tanfoglio Old Generation

Fondina in pelle preformata da cintura. Sgancio rapido e vite di ritenzione, supporto avvitato. Posizione inclinata sul fianco destro.

Duty leather belt holster. Quick release and retention screw. Belt loop support, inclination on the right side position.

COLORI DISPONIBILI/COLOUR AVAILABLE

■ Nero/Black

Disponibile per

FON 11	Beretta 92/98 auto	PB 120
FON 9	Beretta 84 S/auto	PB 121
FON 10	Revolver	PB 128
FON 12	H&K USP Glock 20/21	PB 124
FON 13	S8000 Sig Sauer P225 P228 P229	PB 122
FON 14	H&K P7	PB 124
FON 15	Glock 19/23/25 S&W auto 4"	PB 125
FON 16	Glock 17/22 Ruger P85 8990 Sig p220/7	PB 127
FON 17	Glock 29/30 H&K USP compact	PB 146
FON 18	Walther 99	PB 130
FON 19	Colt 45 government	PB 129

P 1

Fondina da cintura

Fondina in pelle da cintura con sgancio rapido posizione inclinata sul fianco destro.

Duty leather belt holster. Quick release. Right side inclination position.

**COLORI DISPONIBILI
COLOUR AVAILABLE**

■ Nero/Black



Disponibile per

P 100	Beretta 92/98 auto
P 101	Beretta 84 S/auto
P 102	Revolver 4"
P 146	Glock 29/30
P 125	Glock 17/22/31/19/23/32
P 140	Glock 20/21

ACCESSORI per cinture cordura/polimero

ACCESSORIES



ACC 3

Porta caricatore singolo

Porta caricatore in cordura con passante nastro regolabile a velcro.

Nylon magazine case, adjustable nylon belt loop.

ACC 2

Porta caricatore doppio



C cm 3,7

ACC 8

Porta pila serie C

Porta pila/manganello da cintura in polimero.

Polymer baton, flashlight c/cell holder with plastic ring.



D cm 4,4

ACC 9

Porta pila serie D



ACC 19

Belt keeper

Belt keeper in polimero. Confezione da 4 pezzi.

Molded belt keepers.



ACC 13

Porta manette chiuso

Porta manette in cordura chiuso passante nastro con bottoni.

Nylon handcuffs case. Nylon belt loop with snaps.



ACC 22

Correggiolo

Correggiolo in polimero doppio bottone finali termofusi, per pistola.

Polymer pistol safety lace.



ACC 23

Porta radio a farfalla

Porta radio a farfalla universale in tela/cordura, nastri regolabili, passante polimero girevole e amovibile.

Nylon universal radio case. Removable polymer belt loop.

ACCESSORI per cinture pelle

ACCESSORIES



ACC 5

Porta caricatore singolo

Porta caricatore pelle bifilare con bottone.

Leather magazine case bi-filar. Two snaps.

ACC 4

Porta caricatore doppio



C cm 3,7

ACC 10

Porta pila serie C

Porta pila/manganello da cintura in pelle.

Baton/flashlight holder.



D cm 4,4

ACC 11

Porta pila serie D



ACC 21

Belt keeper

Belt keeper in pelle. Confezione da 4 pezzi.

Leather beltkeeper with two snaps.



ACC 15

Porta manette chiuso

Porta manette in pelle chiuso.

Leather handcuffs case.

PORTA TESSERE/PLACCA



POT 2

Portafoglio/Portatessera

Portatessera e portafoglio in pelle con porta placca estraibile per placche U.S. Placche escluse.

Leather ID/badge wallet. Various compartments, with removable badge holder.



POT 7

Porta placca con catenella

Porta placca da cintura con passante per cintura e da collo con catenella per placche U.S. Placche escluse.

Leather badge holder with chain or belt loop.



POT 15

Portafoglio/Portatessera

Portatessera e portafoglio in pelle con porta placca estraibile per placche mod. tondo raggera. Placche escluse.

Leather ID/badge wallet. Various compartments, with removable badge holder.



POT 16

Porta placca con catenella

Porta placca da cintura con passante per cintura e da collo con catenella per placche modello tondo raggera. Placche escluse.

Leather badge holder with chain or belt loop.



POT 13

Portafoglio/Portatessera

Portatessera e portafoglio in pelle con porta placca estraibile per placche mod. araldico. Placche escluse.

Leather ID/badge wallet. Various compartments, with removable badge holder.



POT 14

Porta placca con catenella

Porta placca da cintura con passante per cintura e da collo con catenella per placche modello araldico. Placche escluse.

Leather badge holder with chain or belt loop.

GUANTI

GLOVES



RI38
Guanto cotone

Guanto in cotone colore bianco per alta uniforme.

White cotton glove for high uniform.



EU600
Guanto pelle sfoderato

Guanti in pelle estivi oppure invernali, morbidi e leggeri con cuciture interne, tre nervature cucite sul dorso, elastico di ritenzione sul polso e spacchetto laterale.

Summer or winter leather gloves, soft and light with internal seams, three ribs sewn on the back, elastic retention on the wrist and side slit.

EU650
Guanto pelle invernale foderato

TAGLIE DISPONIBILI

XS | S | M | L | XL | XXL



PL756
Guanto moto estivo

Guanto da moto estivo realizzato in cordura con rinforzo in pelle e protezione di poliuretano espanso sul palmo; inserto in Kevlar sul dorso in corrispondenza delle nocche, parti infradito realizzate in suede e pelle, modellatura alta con inserto in 3M, elastico e cinturino con velcro sul polso.

Summer motorcycle glove made of Cordura with leather inserts and protections.

TAGLIE DISPONIBILI

7 | 7 ½ | 8 | 8 ½ | 9 | 9 ½ | 10



PL753M
Guanto moto invernale

Guanto da moto invernale realizzato in cordura con rinforzo in pelle e protezione di poliuretano espanso sul palmo; inserto in Kevlar sul dorso in corrispondenza delle nocche e di tre dita, parti infradito realizzate in suede e pelle, imbottitura interna in ovatta con membrana in Thinsulate impermeabile e traspirante, modellatura alta, elastico e cinturino con velcro sul polso.

Winter motorcycle glove made of Cordura with leather inserts and protections.

TAGLIE DISPONIBILI

7 | 7 ½ | 8 | 8 ½ | 9 | 9 ½ | 10

GUANTI

GLOVES



OG07

Guanto antipuntura antitaglio

Guanto tessuto elastico comfort sul dorso e pelle foderata, sul palmo e sulle dita fronte e retro in "Elephant Shark Skin", innovativo tessuto con resistenza al taglio e alla puntura di strumenti accuminati quali siringhe, ideale per perquisizioni. Laccio in plastica sul polso.

Glove whit Elastic woven on the back and leather on the palm and on the fingers with lining in "Elephant Shark Skin" a new special woven with a good cut-resistance and a high puncture-resistance.

TAGLIE DISPONIBILI

S | M | L | XL | XXL



OG04

Guanto neoprene multiuso

Guanto multiuso in neoprene e pelle sul palmo per una maggiore sensibilità e tenuta.

Parte in gomma antiscivolo nei punti di impugnatura dell'arma. Regolazione sul polso tramite velcro.

Glove with leather on the palm for better sensibility and grip. No slip rubber on the pistol grip. Adjustable velcro closure.

TAGLIE DISPONIBILI

S | M | L | XL



OG08

Guanto pelle multiuso

Guanto pelle multiuso foderato in Spectra® speciale tessuto con buona resistenza al taglio (doppia resistenza rispetto ad una fodera in Kevlar della stessa pesantezza). Elastico di ritenzione sul polso.

Glove with Inside good cut resistance Spectra® lined leather glove (double resistance respect a kevlar lining with the same weight).

TAGLIE DISPONIBILI

S | M | L | XL | XXL

BORSE

BAGS



BOR 4

**Borsetta porta chiavi
Blu**

Borsetta porta chiavi realizzata in nylon con anello e cerniera, finestra frontale e tasca sul dorso.
Dimensioni: cm 28,5x21x1

Nylon key bag with ring, zipper and front window.

BOR 5

**Borsetta porta chiavi
Nero**



BOR 17

**Busta porta chiavi
Blu**

Busta porta chiavi realizzata in nylon con anello e finestra.
Dimensioni: cm 20x10x1

Nylon key bag with ring and front window



BOR 6

**Borsa porta chiavi morbida
Blu**

Borsa porta chiavi realizzata in nylon morbida con fondo piatto, cerniera unica e maniglie per trasporto.
Dimensioni: cm 60x25x30

Soft nylon key bag with flat bottom.



BOR 7

**Borsa porta chiavi morbida
Nero**

Borsa porta chiavi realizzata in nylon morbida con fondo piatto, cerniera unica e maniglie per trasporto.
Dimensioni: cm 60x25x30

Soft nylon key bag with flat bottom.



BOR 16

Borsa banca d'Italia

Borsone morbido realizzato in nylon colore blu modello Banca d'Italia (misure regolari previste per trasporto su carrelli portasoldi della Banca d'Italia), fondo plastificato.
Dimensioni : cm 60x40x20

Soft nylon key bag with flat plastic bottom, Bank of Italy model.



Tutti gli articoli sono personalizzati con il logo dell'istituto

MANGANELLI e MANETTE

BATON AND HANDCUFF



OE 99

Bastone retrattile rigido

Bastone retrattile rigido con impugnatura anatomica in gomma, con fodero in nylon incluso. Lunghezza cm 53.

Expandable rigid stick with anatomic rubber handle, nylon pouch included.



OM 40

Manganello in gomma

Manganello in gomma con impugnatura rigata antiscivolo. Lunghezza cm 60. colore bianco / nero

Rubber baton, no slip handle.



OM 41

Bastone tonfa

Bastone tonfa in polietilene con impugnatura rigata antiscivolo. Lunghezza cm 58.

Polytilene tonfa baton, rulled handle.



OM 42

Bastone tonfa retrattile

Bastone tonfa retrattile in lega con impugnatura rigata. Lunghezza cm 59.

Aloy expandable tonfa rulled handle.



SFO 1

Manette

Manette in acciaio inox tipo spagnolo.

Special stainless steel handcuffs.



KIMAY per lo SPORT ed il TEMPO LIBERO

KIMAY for SPORT and FREE TIME







PARTNERS

partners

Personalizziamo una vasta gamma di articoli promozionali: polo, t-shirt, felpe, giubbini, cappellini ecc., che possono soddisfare le vostre esigenze.

rossini.



actionwear





SCHEDE MISURE

polo uomo manica corta due bottoni

taglia US	XXS	XS	S	M	L	XL	XXL
1 lunghezza centro dietro	62,5	64,5	66,5	68,5	70,5	72,5	74,5
2 larghezza spalle	38,6	39,9	41,2	42,5	43,8	45,1	46,4
3 1/2 torace 2cm sotto giro manica	46	48	50	52	54	56	59
4 lunghezza manica	22	22,5	23	23,5	24	24,5	25
5 1/2 fondo manica	14,8	15,4	16	16,6	17,2	17,8	18,4

taglia US	3XL	4XL	5XL	6XL	7XL	8XL	9XL
1 lunghezza centro dietro	76,5	78,5	79,2	79,9	80,6	81,3	82
2 larghezza spalle	47,7	49	50,3	51,6	52,9	54,2	55,5
3 1/2 torace 2cm sotto giro manica	62	65	68	71	74	77	80
4 lunghezza manica	25,5	26	26,25	26,5	26,75	27	27,25
5 1/2 fondo manica	19	19,6	20,2	20,8	21,4	22	22,6

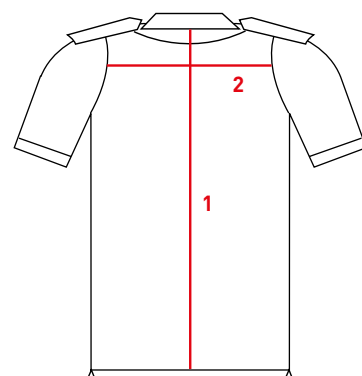
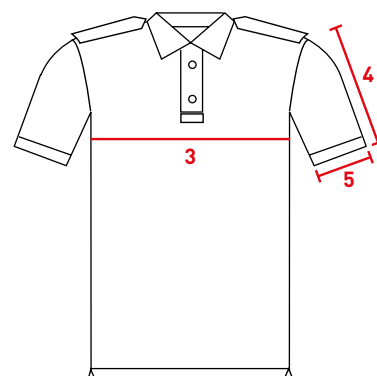

camicia US uomo manica lunga

taglia Italiana	34	35	36	37	38	39	40	41	42	43	44	45
taglia US	XXS	XS	S	M	L	XL						
1 lunghezza centro dietro	71	71,5	72	72,5	73,75	75	76,25	77,5	78,75	80	81,25	82,5
2 larghezza spalle	42,5	43,5	44,5	45,5	46,5	47,5	48,5	49,5	50,5	51,5	52,5	53,5
3 1/2 torace	45,5	47,5	49,5	51,5	53,5	55,5	57,5	59,5	61,5	63,5	65,5	67,5
4 lunghezza manica	57,25	57,5	57,75	58	59,25	60,5	61,75	63	64,25	65,5	66,75	68
5 1/2 muscolo	18,1	18,8	19,5	20,2	20,9	21,6	22,3	23	23,9	24,4	25,1	25,8

taglia Italiana	46	47	48	49	50	51	52	53	54	55
taglia US	XXL	3XL	4XL	5XL	6XL					
1 lunghezza centro dietro	83,75	85	86,25	87,5	88	88,5	89	89,5	90	90,5
2 larghezza spalle	54,5	55,5	56,5	57,5	58,5	59,5	60,5	61,5	62,5	63,5
3 1/2 torace	69,5	71,5	73,5	75,5	77,5	79,5	81,5	83,5	85,5	87,5
4 lunghezza manica	69,25	70,5	71,75	73	73,25	73,5	73,75	74	74,25	74,5
5 1/2 muscolo	26,5	27,2	27,9	28,6	29,3	30	30,7	31,4	32,1	32,8

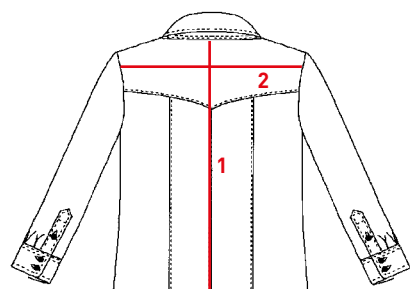
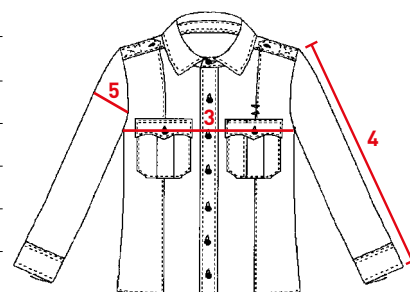

SCHEDE MISURE

maglione

taglia US	XXS	XS	S	M	L	XL	XXL
1 lunghezza	64	65	66	67	68	70	71
2 1/2 torace	48	50	52	54	56	58	60
3 manica da centro collo	82	83	84	85	86	87	88
4 larghezza fine polso	10	11	11	12	12	12,5	12,5

taglia US	3XL	4XL	5XL	6XL	7XL	8XL
1 lunghezza	72	73	74	75	75	75
2 1/2 torace	62	64	66	68	70	72
3 manica da centro collo	89	90	91	92	93	94
4 larghezza fine polso	13	13	14	14	14	14

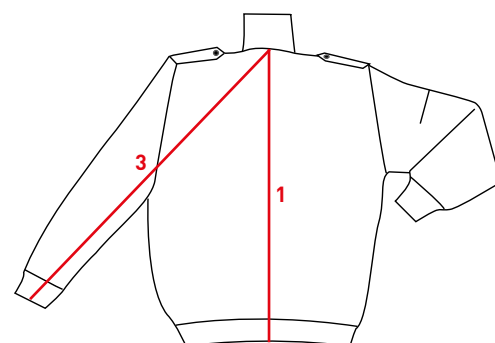
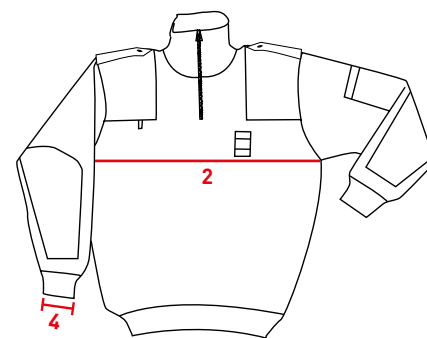

softshell

taglia US	XXS	XS	S	M	L	XL
1 lunghezza centro dietro	64,5	67	69,5	72	74,5	77
2 larghezza spalle	44	46	48	50	52	54
3 1/2 torace	46,5	50,5	54,5	58,5	62,5	66,5
4 lunghezza manica	54,5	57	59,5	62	64,5	67

taglia US	XXL	3XL	4XL	5XL	6XL
1 lunghezza centro dietro	78,75	79,75	80,75	81,75	82,75
2 larghezza spalle	56	58	60	62	64
3 1/2 torace	70,5	74,5	78,5	82,5	86,5
4 lunghezza manica	68,55	69,15	69,75	70,35	70,95

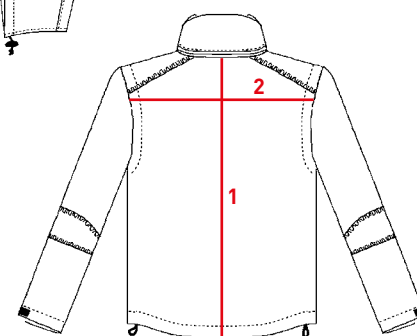
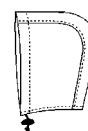
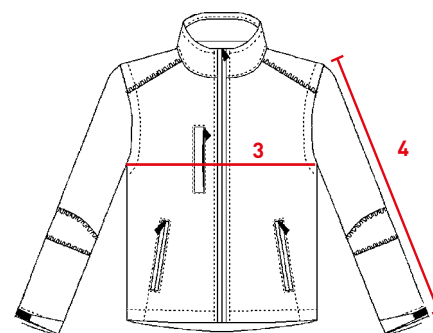

SCHEDE MISURA

giubbino DS

taglia US	XXS	XS	S	M	L	XL	XXL
1 lunghezza centro dietro	60,5	63,5	66,5	69,5	72,5	75,5	78,5
2 larghezza spalle	47,5	49,5	51,5	53,5	55,5	57,5	59,5
3 1/2 torace	49	53	57	61	65	69	73
4 lunghezza manica	54	56,5	59	61,5	64	66,5	69

taglia US	3XL	4XL	5XL	6XL	7XL	8XL
1 lunghezza centro dietro	79,5	80,5	81,5	82,5	83,5	84,5
2 larghezza spalle	61,5	63,5	65,5	67,5	69,5	71,5
3 1/2 torace	77	81	85	89	93	97
4 lunghezza manica	69,6	70,2	70,8	71,4	72	72,6

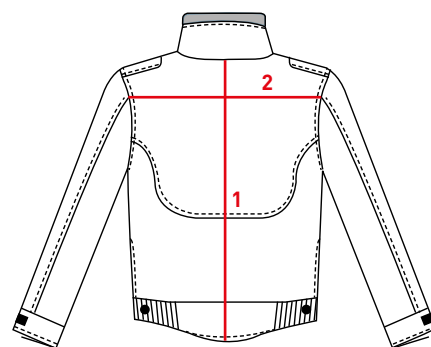
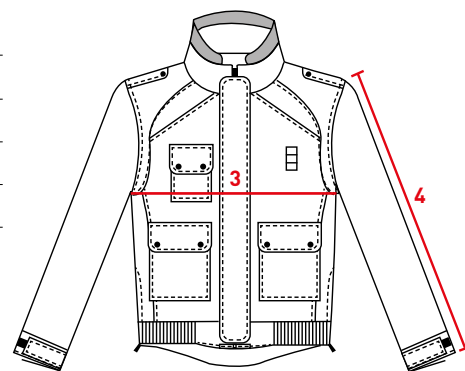

giacca a vento M65

taglia US	XXS	XS	S	M	L	XL	XXL
1 lunghezza centro dietro	70,5	73,5	76,5	79,5	82,5	85,5	88,5
2 larghezza spalle	48,5	50,5	52,5	54,5	56,5	58,5	60,5
3 1/2 torace	52,5	56,5	60,5	64,5	68,5	72,5	76,5
4 lunghezza manica	54	56,5	59	61,5	64	66,5	69
5 1/2 muscolo	24,2	25,4	26,7	28	29,3	30,6	31,8

taglia US	3XL	4XL	5XL	6XL	7XL	8XL
1 lunghezza centro dietro	89,5	90,5	91,5	92,5	93,5	94,5
2 larghezza spalle	62,5	64,5	66,5	68,5	70,5	72,5
3 1/2 torace	80,5	84,5	88,5	92,5	96,5	100,5
4 lunghezza manica	69,6	70,2	70,8	71,4	72	72,6
5 1/2 muscolo	33,1	34,3	35,6	36,9	38,2	39,4

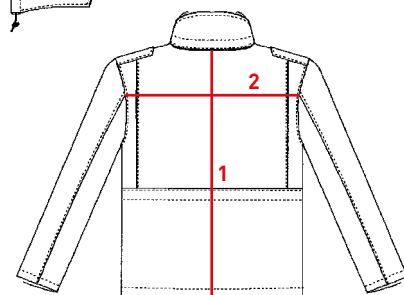
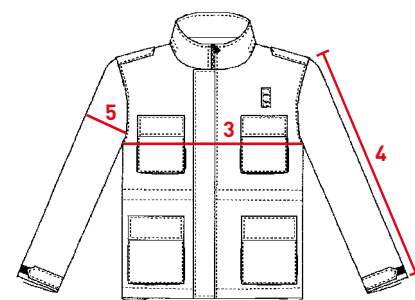

SCHEDE MISURE

pantalone DS 6 tasche

taglia US	XXS	XS	S	M	L	XL
1 1/2 vita rilassata	35	37	39	41	44	47
2 esterno gamba senza cintura	100,5	102	103,5	107	108,5	110
3 1/2 bacino 18 cm sotto cintura x tg.M	48,5	50,5	52,5	54,5	57,5	60,5

taglia US	XXL	3XL	4XL	5XL	6XL	7XL
1 1/2 vita rilassata	50	53	56	59	62	65
2 esterno gamba senza cintura	111,7	112,5	113,4	114,3	115,2	116,1
3 1/2 bacino 18 cm sotto cintura x tg.M	63,5	66,5	69,5	72,5	75,5	78,5

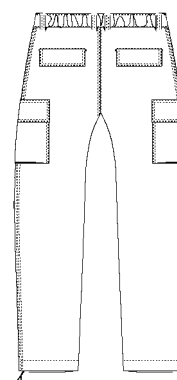
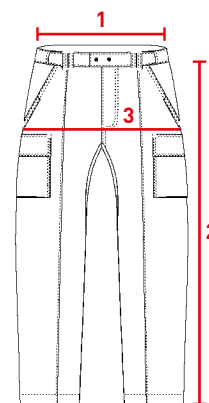

pantalone classico uomo due pences

taglia US	40	42	44	46	48	50	52	54	56	58
1 1/2 vita	35	37	39	41	43	45	47	49	51	53
2 1/2 bacino 18 cm tg.50	49	51	53	55	57	59	61	63	65	67
3 esterno gamba senza cintura	106,5	107,5	108,5	109,5	110,5	111,5	112,5	113,5	114,5	115,5

taglia US	60	62	64	66	68	70	72	74	76
1 1/2 vita	55	57	59	61	63	65	67	69	71
2 1/2 bacino 18 cm tg.50	69	71	73	75	77	79	81	83	85
3 esterno gamba senza cintura	116,5	117,5	118,5	119,5	120,5	121,5	122,5	123,5	124,5

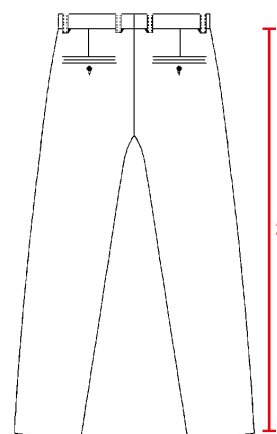
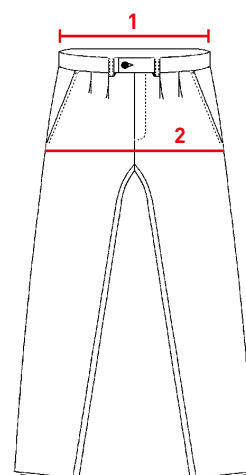

SCHEDE MISURA

giacca diagonale uomo alette tre punte

taglia US	38	40	42	44	46	48	50	52	54
1 lunghezza centro dietro	70	71	72	73	74	75	76	77	78
2 larghezza spalle al carrè	42,2	43,2	44,2	45,2	46,2	47,2	48,2	49,2	50,2
3 1/2 torace	45,5	47,5	49,5	51,5	53,5	55,5	57,5	59,5	61,5
4 lunghezza manica	59,4	60,5	61,6	62,7	63,8	64,9	66	67,1	68,2

taglia US	56	58	60	62	64	66	68	70	72
1 lunghezza centro dietro	79	80	81	82	83	84	85	86	87
2 larghezza spalle al carrè	51,2	52,2	53,2	54,2	55,2	56,2	57,2	58,2	59,2
3 1/2 torace	63,5	65,5	67,5	69,5	71,5	73,5	75,5	77,5	79,5
4 lunghezza manica	69,3	70,4	71,5	72,6	73,1	74,2	75,3	76,4	77,5

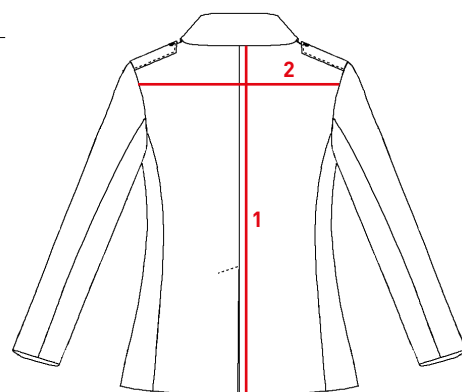
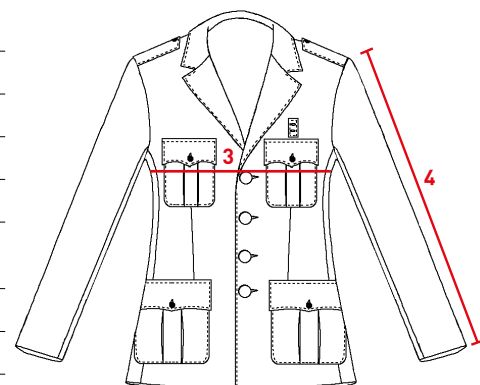

giacca classica uomo tre bottoni

taglia Italiana	42	44	46	48	50	52	54
1 lunghezza centro dietro	69,5	71	72,5	74	75	76	77
2 larghezza 1/2 carrè dietro	42	43	44	45	46	47	48
3 1/2 torace	49	51	53	55	57	59	61
4 lunghezza manica	62	63	64	65	66	66,7	67,4

taglia Italiana	56	58	60	62	64	66	68
1 lunghezza centro dietro	78	78,5	79	79,5	80	80,5	81
2 larghezza 1/2 carrè dietro	49	50	51	52	53	54	55
3 1/2 torace	63	65	67	69	71	73	75
4 lunghezza manica	68,1	68,5	68,9	69,3	69,7	70,1	70,5

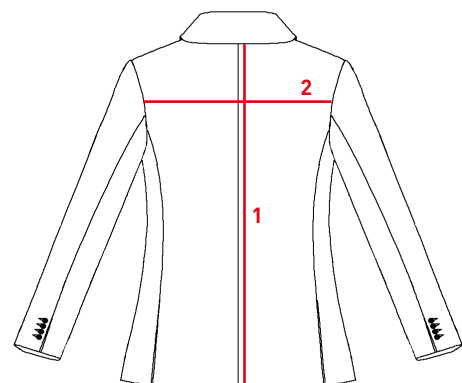
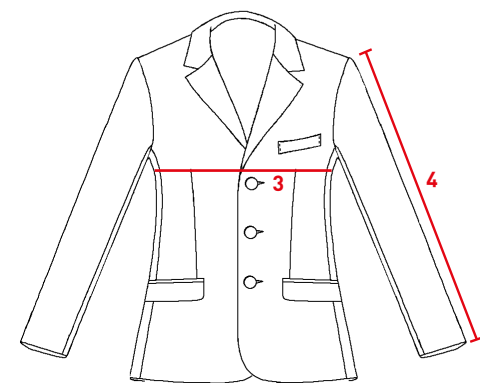

SCHEDE MISURA

giacca classica donna tre bottoni

taglia US	36	38	40	42	44	46	48	50
1 lunghezza centro dietro	66	67	68	69	70	71	72	73
2 schiena carrè	35,7	36,9	38,1	39,3	40,5	41,7	42,9	44,1
3 1/2 torace	40,5	42,5	44,5	46,5	48,5	50,5	52,5	54,5
4 lunghezza manica	57	58	59	60	61	62	63	64

taglia US	52	54	56	58	60	62	64	66
1 lunghezza centro dietro	74	75	76	77	78	79	79,5	80
2 schiena carrè	45,3	46,5	47,7	48,9	50,1	51,3	52,5	53,7
3 1/2 torace	56,5	58,5	60,5	62,5	64,5	66,5	68,5	70,5
4 lunghezza manica	65	66	67	68	69	69,3	69,6	69,9

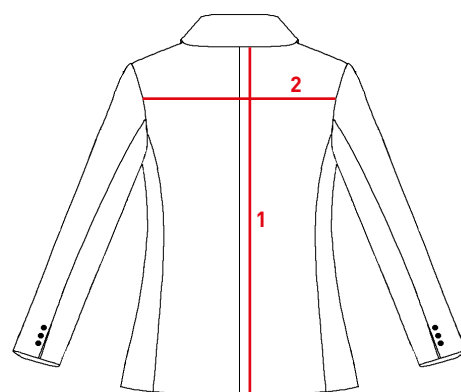
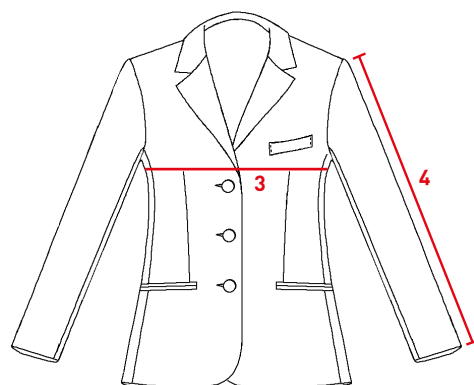

pantalone classico donna benetton

taglia Italiana	34	36	38	40	42	44	46
1 1/2 vita	29	31	33	35	37	39	41
2 1/2 bacino 18 cm tg.50	40,5	42,5	44,5	46,5	48,5	50,5	52,5
3 esterno gamba senza cintura	103,5	104	104,5	106	106,5	108	109,5

taglia Italiana	48	50	52	54	56	58	60
1 1/2 vita	43	45	47	49	51	53	55
2 1/2 bacino 18 cm tg.50	54,5	56,5	58,5	60,5	62,5	64,5	66,5
3 esterno gamba senza cintura	111	112,5	114	114,5	115	115,5	116

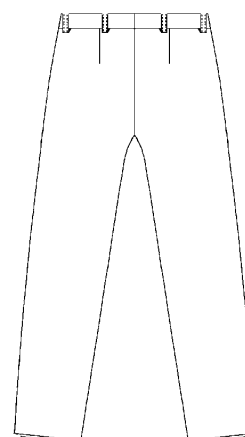
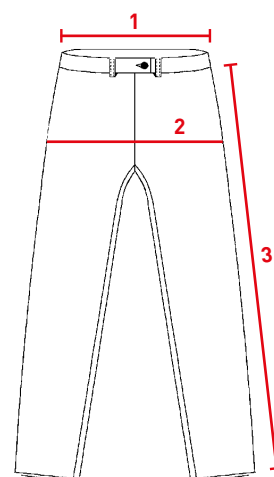



Kimay®
Uniforms & Body Armor
ITALY

Via Vaglietta 19 - 24040 Lallio (BG) Italy
Tel. +39 035 373237 - Fax + 39 035 373238
info@kimay.it - www.kimay.it

COMPILATORE

DATA

Confezionare

AZIENDA

SIGNOR/A

MISURE	
Altezza	cm.
Peso	kg.
Circonferenza collo	cm.
Circonferenza testa	cm.

TAGLIE PORTATE ABITUALMENTE

GIACCA	Tag.
CAMICIA	Tag.
PANTALONE	Tag.
GIACCONE	Tag.
MAGLIONE	Tag.
CALZATURE	Tag.

SI PREGA DI COMPILARE
CON LA MASSIMA ATTENZIONE

Nel prendere le misure il centimetro non deve essere nè tirato nè lento

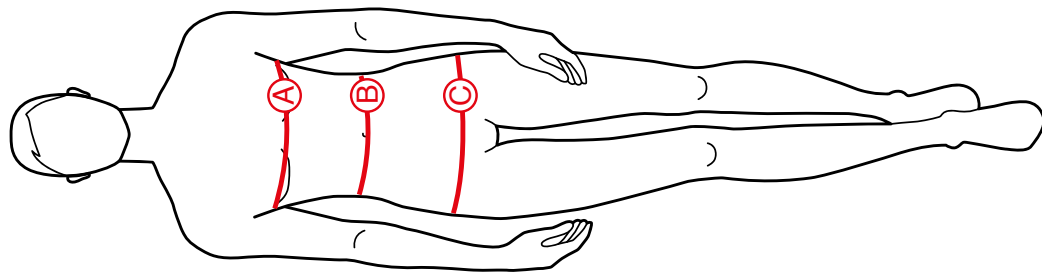

A CIRCONFERENZA TORACE

Sotto le ascelle

cm.

B CIRCONFERENZA VITA

Prenderla sul punto vita aderente al corpo

cm.

C CIRCONFERENZA BACINO

Al punto massimo di sviluppo

cm.

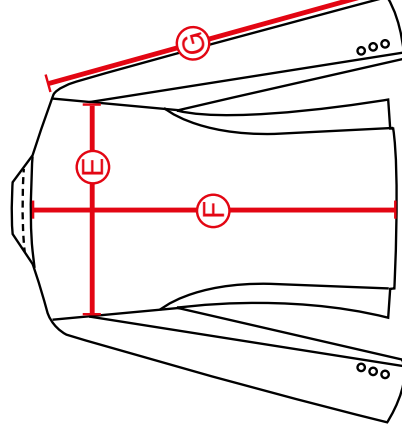

E LARGHEZZA SPALLE

Dall'attaccatura delle maniche

cm.

F LUNGHEZZA GIACCA

Dall'attaccatura del bavero al fondo della giacca

cm.

G LUNGHEZZA MANICA

A braccio disteso

cm.

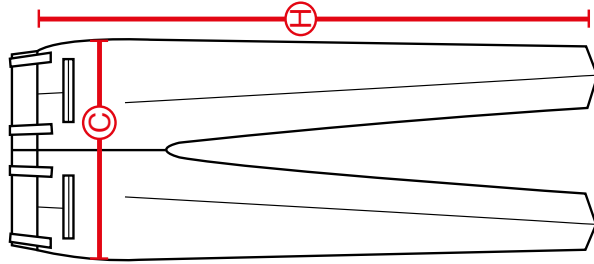

H LUNGHEZZA PANTALONI

Sotto cintura dal punto incavo vita fino in fondo (da sotto cintura)

cm.

.....

.....

.....

.....

.....

.....

SCHEDA RILEVAZIONE TAGLIA DONNA



Via Vaglietta 19 - 24040 Lallio (BG) Italy
 Tel. +39 035 373237 - Fax +39 035 373238
 info@kimay.it - www.kimay.it

Confezionare

.....

AZIENDA

SIGNOR/A

MISURE	
Altezza	cm.
Peso	kg.
Circonferenza collo	cm.
Circonferenza testa	cm.
TAGLIE PORTATE ABITUALMENTE	
GIACCA	Tag.
CAMICIA	Tag.
PANTALONE	Tag.
GONNA	Tag.
GIACCONE	Tag.
MAGLIONE	Tag.
CALZATURE	Tag.

SI PREGA DI COMPILARE CON LA MASSIMA ATTENZIONE

Net prendere le misure il centimetro non deve essere nè tirato nè lento

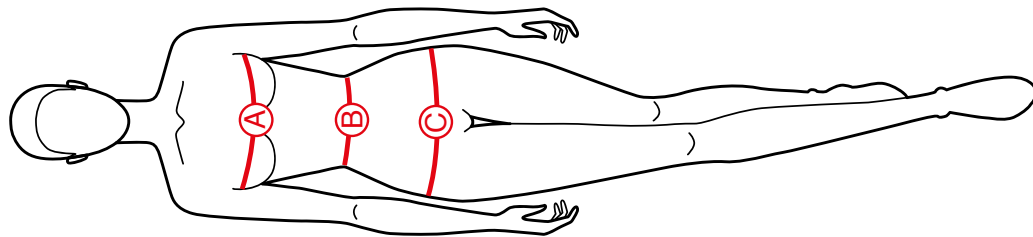

(A) CIRCONFERENZA TORACE

Misurato sul punto seno

cm.

(B) CIRCONFERENZA VITA

Prenderla sul punto vita aderente al corpo

cm.

(C) CIRCONFERENZA BACINO

Al punto massimo di sviluppo

cm.

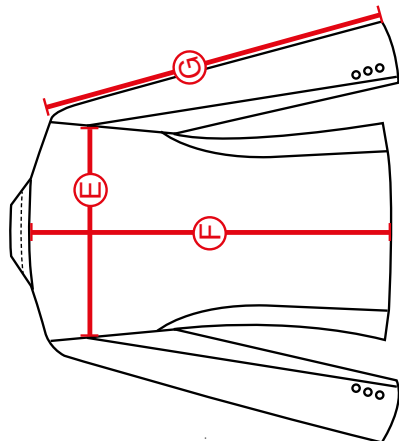

(E) LARGHEZZA SPALLE

Dall'attaccatura delle maniche

cm.

(F) LUNGHEZZA GIACCA

Dall'attaccatura del bavero al fondo della giacca

cm.

(G) LUNGHEZZA MANICA

A braccio disteso

cm.

(H) LUNGHEZZA PANTALONI

Sotto cintura dal punto incavo vita fino in fondo (da sotto cintura)

cm.

(I) LUNGHEZZA GONNA

Sotto cintura dal punto incavo vita fino in fondo (da sotto cintura)

cm.

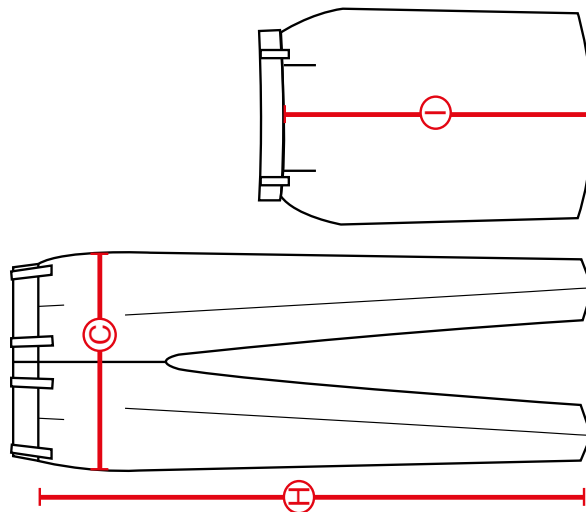



GUARDIA
GIURATA

KIMAY

GUARDIA
GIURATA



www.kimay.it